

SVENSKA
ENGLISH
DEUTSCH
ESPAÑOL
FRANÇAIS
SUOMI
NORSK
DANSK
NEDERLANDS

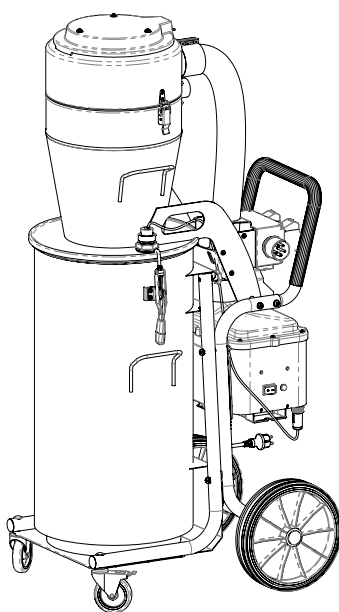

DC Chip Extractor

Art.nr. 99076-A
2024-09-30

Innehållsförteckning

DC Chip Extractor	8
Rättsligt meddelande	8
Säkerhetsföreskrifter	9
Intro	9
Varning	9
Miljöskydd	9
WEEE (Waste of Electric and Electronic Equipment)	10
Arbetsmiljö	10
Överbelastning	10
Kroppskador	10
Elkabel	11
Viktig åtgärd	11
Omsorg	11
Kontroll	11
Funktionsbeskrivning	12
Tekniska data	13
Drift	14
Anslut	14
Automatisk Startapparat (ALV10)	14
Filterrensning	14
Tömning	15
Service/Underhåll	17
Rengöring	17
Filterbyte	17
Motor	18
Regelbunden kontroll	19
Tillbehör & Förbrukningsartiklar	20
Garanti	21
Motor	21
Felsökning	22
EG-försäkring	23
Kontakt	24
DC Chip Extractor	25
Legal notice	25
Safety regulations	26
Intro	26
Warning	26
Environmental protection	26
WEEE (Waste of Electric and Electronic Equipment)	27
Work environment	27
Overload	27
Bodily injuries	27
Electric cable	28
Important action	28
Care	28
Control	28
Functional description	29
Technical data	30
Operation	31
Connection	31
Automatic Starter (ALV10)	31
Filter cleaning	31
Emptying	32
Service/Maintenance	34
Cleaning	34
Filter replacement	34
Motor	35
Regular check	36
Accessories & Consumables	37

Warranty	38
Engine	38
Troubleshooting	39
EC Declaration of Conformity	40
Contact	41
DC Chip Extractor	42
Rechtlicher Hinweis	42
Sicherheitsvorschriften	43
Einführung	43
Warnung	43
Umweltschutz	43
WEEE (Abfall von Elektro- und Elektronik- Altgeräte)	44
Arbeitsumfeld	44
Überlast	44
Körperverletzungen	44
Stromkabel	45
Wichtige Aktion	45
Pflege	45
Kontrolle	45
Funktionsbeschreibung	46
Technische Daten	47
Betrieb	48
Anschließen	48
Automatischer Starter (ALV10)	48
Filterreinigung	48
Leeren	49
Service/Wartung	51
Reinigung	51
Filterwechsel	51
Motor	53
Regelmäßige Kontrolle	54
Zubehör und Verbrauchsmaterialien	55
Gewährleistung	56
Motor	56
Fehlersuche und -behebung	57
EG-Konformitätserklärung	58
Kontakt	59
DC Chip Extractor	60
Aviso legal	60
Normas de seguridad	61
Introducción	61
Advertencia	61
Protección ambiental	61
RAEE (Residuos de aparatos eléctricos y electrónicos)	62
Ambiente de trabajo	62
Sobrecarga	62
Lesiones corporales	62
cable electrico	63
Acción importante	63
Cuidado	63
Control	63
Descripción de las funciones	64
Datos técnicos	65
Operación	66
Conexión	66
Arrancador automático (ALV10)	66
Limpieza de filtros	66
Drenar	67
Puesta a punto/Mantenimiento	69
Limpieza	69
Cambio de los filtros	69
Motor	70

Control periódico	71
Accesorios y consumibles	72
Garantía	73
Motor	73
Detección y resolución de problemas	74
Declaración de conformidad para el mercado CE	75
Contacto	76
DC Chip Extractor	77
Mentions légales	77
Règles de sécurité	78
Introduction	78
Avertissement	78
Protection de l'environnement	78
DEEE (Déchets d'équipements électriques et électroniques)	79
Environnement de travail	79
Surcharge	79
Blessures corporelles	79
Câble électrique	80
Action importante	80
Soins	80
Contrôle	80
Description fonctionnelle	81
Caractéristiques techniques	82
Opération	83
Branchement	83
Démarreur automatique (ALV10)	83
Nettoyage du filtre	83
Vidange	84
Entretien/maintenance	86
Nettoyage	86
Remplacement de filtre	86
Moteur	87
Contrôle régulier	88
Accessoires et consommables	89
Garantie	90
Moteur	90
Recherche de pannes	91
Déclaration CE	92
Contact	93
DC Chip Extractor	94
Oikeudellinen huomautus	94
Turvallisuusmääräykset	95
Johdanto	95
Varoitus	95
Ympäristönsuojelu	95
WEEE (Waste of Electric and Electronic Equipment)	96
Työympäristö	96
Ylikuormitus	96
Ruumiinvammat	96
Sähkökaapeli	97
Tärkeä toimenpide	97
Hoito	97
Ohjaus	97
Toimintojen kuvaus	98
Tekniset tiedot	99
Toiminta	100
Kytkeminen	100
Automaattikäynnistin (ALV10)	100
Suodattimen puhdistus	100
Valua	101
Huolto/Ylläpito	103
Puhdistus	103

Suodattimen vaihto	103
Moottori	104
Säännöllinen tarkastus	105
Tarvikkeet ja kulutustarvikkeet	106
Takuu	107
Moottori	107
Vianmääritys	108
EY-vaatimustenmukaisuusvakuutus	109
Ota yhteyttä	110
DC Chip Extractor	111
Juridisk varsel	111
Sikkerhetsforskrifter	112
Intro	112
Advarsel	112
Miljøvern	112
WEEE (Waste of Electric and Electronic Equipment)	113
Arbeidsmiljø	113
Overbelastning	113
Kroppsskader	113
Elektrisk kabel	114
Viktig handling	114
Omsorg	114
Kontroll	114
Funksjonsbeskrivelse	115
Tekniske data	116
Operasjon	117
Tilkobling	117
Automatisk starter (ALV10)	117
Rengjøring av filter	117
Drenere	118
Service/vedlikehold	120
Rengjøring	120
Bytte filter	120
Motor	121
Regelmessig sjekk	122
Tilbehør og forbruksvarer	123
Garanti	124
Motor	124
Feilsøking	125
EU-erklæring	126
Kontakt	127
DC Chip Extractor	128
Juridisk meddelelse	128
Sikkerhedsbestemmelser	129
Intro	129
Advarsel	129
Miljøbeskyttelse	129
WEEE (Waste of Electric and Electronic Equipment)	130
Arbejds miljø	130
Overbelaste	130
Kropsskader	130
Elektrisk kabel	131
Vigtig handling	131
Omsorg	131
Kontrollere	131
Funktionsbeskrivelse	132
Tekniske data	133
Operation	134
Tilslutning	134
Automatisk starter (ALV10)	134
Filterrensning	134
Dræne	135

Service/vedligeholdelse	137
Rengøring	137
Filterskift	137
Motor	138
Regelmæssig kontrol	139
Tilbehør og forbrugsvarer	140
Garanti	141
Motor	141
Fejlfinding	142
EF-overenstemmelseserklæring	143
Kontakte	144
DC Chip Extractor	145
Juridische mededeling	145
Veiligheidsvoorschriften	146
Intro	146
Waarschuwing	146
Milieubescherming	146
WEEE (Waste of Electric and Electronic Equipment), ofwel AEEA: Afval van elektrische en elektronische apparatuur	147
Werkomgeving	147
Overbelasting	147
Lichamelijke verwondingen	147
Elektrische kabel	148
Belangrijke actie	148
Zorg	148
Controle	148
Beschrijving van de werking	149
Technische gegevens	150
Operatie	151
Aansluiting	151
Automatische starter (ALV10)	151
Filterreiniging	151
Droogleggen	152
Service/onderhoud	154
Schoonmaken	154
Filter vervangen	154
Motor	156
Regelmatige controle	157
Accessoires en verbruiksartikelen	158
Garantie	159
Motor	159
Probleemoplossing	160
EG-verklaring	161
Contact	162

Rättsligt meddelande

**OBS!**

Bruksanvisning i original

**VIKTIGT**

Läs bruksanvisningen före användning av maskinen.

**VIKTIGT**

Dustcontrol förbehåller sig rätten att ändra specifikationer utan förvarning och är inte skyldig att ändra tidigare levererade produkter. Dustcontrol ansvarar inte för fel eller utelämnanden i denna bruksanvisning.

**VIKTIGT**

Alla relevanta statliga, regionala och lokala säkerhetsföreskrifter måste följas vid installation och användning av denna produkt. Av säkerhetsskäl och för att säkerställa överensstämmelse med dokumenterade systemdata ska endast tillverkaren utföra reparationer av komponenter. Underlåtenhet att följa denna information kan leda till personskador eller skador på utrustningen.

**VIKTIGT**

Alla rättigheter förbehållna. Ingen del av denna publikation får reproduceras, distribueras eller överföras i någon form eller på något sätt, inklusive fotokopiering, inspelning eller andra elektroniska eller mekaniska metoder, utan föregående skriftligt tillstånd från utgivaren. För tillståndsförfrågningar, kontakta Dustcontrol.

**OBS!**

Produkten tillverkas av:

Dustcontrol AB
Box 3088, Kumla Gårdsväg 14
SE-145 03 Norsborg
Tel: +46 8 531 940 00
support@dustcontrol.se
www.dustcontrol.com

Säkerhetsföreskrifter

Intro

Läs följande säkerhetsföreskrift innan du startar denna maskin. Spara bruksanvisningen. Om inte säkerhetsföreskriften följs gäller inte garanti. Person- och produktskada kan även uppstå. Dustcontrol ansvarar ej för skador på utrustningen som uppkommit på grund av felaktig installation eller felaktigt handhavande av utrustningen.

Varning

Denna maskin är endast avsedd för professionellt bruk.

Barn skall övervakas för att säkerställa att de inte leker med maskinen.

Använd endast originaltillbehör och förbrukningsartiklar som ingår i Dustcontrols sortiment.



VARNING

Använd maskinen för avsett ändamål. Följ föreskrifterna för det material som sugs.



VARNING

Denna maskin är endast avsedd för uppsugning av torrt material.



VARNING

Vid användandet av elektriska enheter ska grundläggande säkerhetsföreskrifter följas för att minska risken för brand, elstöt eller personskada.



VARNING

Inga heta, glödande partiklar eller andra antändningskällor får sugas in i maskinen. Maskinen ska ej användas för explosiva, instabila eller självantändliga partiklar.



VARNING

Endast Dustcontrols filter får användas. Om andra filter används hävs garantin. Vid användande av undermåliga filter finns risk för person eller produktskada.

Miljöskydd

Återvinn emballage och ingående komponenter enligt lokala föreskrifter. För mer information kontakta er närmaste återvinningscentral eller Dustcontrol för skrotning av maskin.

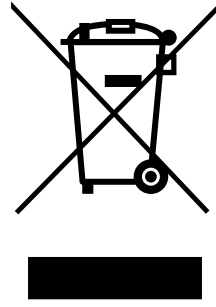
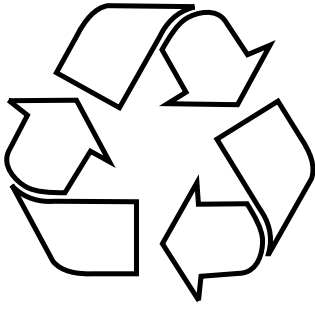

WEEE (Waste of Electric and Electronic Equipment)

Gäller endast EU-länder: Elektriska verktyg får inte kastas i hushållssoporna. Enligt direktivet 2002/96/EG som avser äldre elektrisk och elektronisk utrustning och dess tillämpning enligt nationell lagstiftning ska uttjänta elektriska verktyg sorteras separat och lämnas till miljövänlig återvinning.

Arbetsmiljö

Utsätt inte maskinen för väta. Använd den ej i fuktiga och våta utrymmen eller i närheten av lättantändliga vätskor eller gaser.



OBSERVERA

Denna maskin får endast användas och förvaras i torr miljö.



OBSERVERA

Maskinen får ej sköljas med vatten.

Överbelastning



OBSERVERA

Låt aldrig maskinen arbeta helt strypt eftersom detta innebär en risk för överhettning.

Kroppskador



VARNING

Försök aldrig att på egen hand ändra elektriska kopplingar. Ett fel kan medföra livsfara!



VARNING

Låt aldrig sugpunkten komma i kontakt med någon kroppsdel. Det starka undertrycket kan skada hudens blodkärl.



VARNING

Vid montering, hantering och transport av produkten ska skyddshandskar användas.

Elkabel



VARNING

Dra aldrig maskinen med hjälp av elkabeln. Utsätt inte elkabeln för värme eller skarpa föremål. Kontrollera elkabeln regelbundet.

Vid koppling av elkabel till skarvsladd måste skarvsladden vara vattenskyddad (IP44).

Maskinen får inte användas om elkablarna eller kontakterna är skadade.

Om elkabeln är skadad måste den bytas av Dustcontrol eller av Dustcontrol auktoriserad serviceverkstad.

Viktig åtgärd

Stäng av huvudströmbrytaren och koppla bort maskinen från elnätet innan du rengör eller utför underhåll på maskinen.

Denna maskin får endast användas om alla filter är oskadade och rätt monterade.

Omsorg

Håll maskinen ren och fri från stoftavlagringar. Se till att sugslangen är hel och att alla tätningar är intakta och felfria. Håll bärhandtagen torra och fria från olja och fett.

Kontroll

Kontrollera regelbundet att enheten inte har skador eller förslitningar. Uppstår skador ska dessa åtgärdas av Dustcontrols servicetekniker eller av en Dustcontrol auktoriserad serviceverkstad.

Funktionsbeskrivning

Stoftavskiljaren arbetar med undertryck (sug) som driver luften genom sugkåpa/munstycke, slangsystem samt för- och stoftavskiljare. Grovavskiljning sker i enhetens cyklon, vilket är en mycket effektiv avskiljning av allt grövre damm. Findammet avskiljes i enhetens filter. Filterrensning med luftpuls ger filtren extra lång livslängd. Maskinen är utrustad med HEPA-filtre.

DC Chip Extractor är speciellt framtagen för att kopplas ihop med Gjerdesågen. Den är även lämplig för punktutdrag på de flesta sågar där det finns krav på kontinuerlig drift och hög avskiljningsgrad.

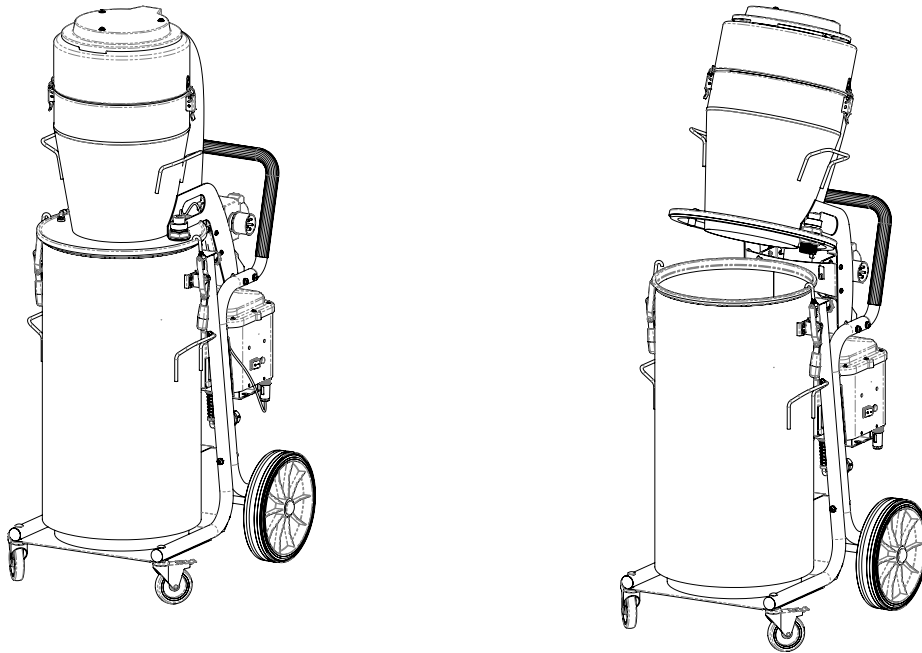

Stoftavskiljaren har följande utmatningsmöjlighet:

a- Behållare: En cylindrisk behållare för uppsamling av avskilt material.

Tekniska data

Tekniska data	DC Chip Extractor
HxBxD [mm]	1530 x 600 x 780
Vikt [kg]	70
Inlopp Ø [mm]	76
Slanglängd Ø50mm [m]	7.5
Uppsamlingsbehållare [l]	90
Flöde max. fläkt (EU) 230V [m ³ /h]	355
Undertryck max [kPa]	22
Effektuttag (EU) 230V [W]	2600
Finfilter polyester, area [m ²]	1.85
Avskiljningsgrad finfilter, EN 60335-2-69, Klass M [%]	99.9
Filteryta mikrofilter [m ²]	2.2
Filterklassificering, EN 1822-1	HEPA H13
Avskiljningsgrad maskinen, EN 60335-2-69, Bilaga A-A, Klass H [%]	99.995
Ljudnivå [dB(A)]	70
Art no.	174100

Drift

Anslut

Anslut maskinen till ett eluttag med spänning enligt specifikationerna på maskinens märkplåt.

Automatisk Startapparat (ALV10)

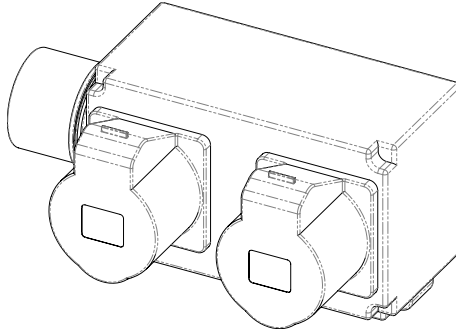

Enligt gällande säkerhetsförfordningar vid arbete med träbearbetningsmaskiner, skall hälsofarligt damm effektivt sugas upp av en spånsug.

Denna startapparat med tidsfördröjning, startar automatiskt spånsugen efter 2-3 sekunder och skyddar därför en överbelastning på säkringen.

Efter det att maskinen stoppats, går spånsugen ytterligare 3-4 sekunder och suger på så sätt upp resterande stoff ur slangarna.

Filterrensning

Maskinen har en filterindikationslampa som lyser när filtret behöver rensas eller bytas.

Instruktioner för filterrensning

1. Låt maskinen vara påslagen, ställ om filterrensningsknappen och stäng spjället på cyklonens inlopp.
2. Vänta 5-10 pulser.
3. Stäng av maskinen.
4. Återställ filterrensningsknappen och öppna spjället på cyklonens inlopp.
5. Starta maskinen. Kontrollera att filterindikationslampan är släckt. Om inte - upprepa proceduren. Om lampan lyser även efter repetitionen behöver finfiltret bytas.

Filter Lamp 

- 1 
- 2 

"Poff..."
5 - 10
times
- 3 **POWER OFF**
- 4 
- 5 **POWER ON** → Filter Lamp 

Tömning



OBS!

Nivågivare varnar när tunnan är full och behöver tömmas.

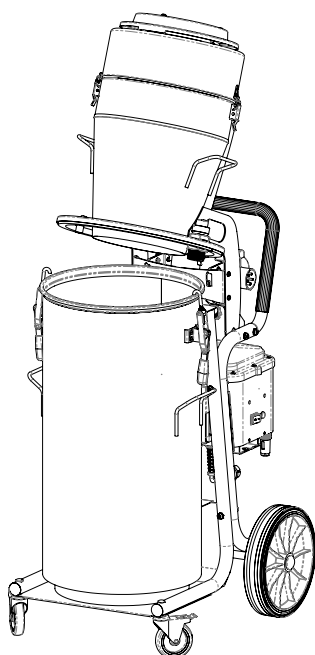

1. Lossa spännena som håller fast locket på tunnan.
2. Lyft bak cyklonen med hjälp av handtagen på cyklonens sida. Se ovanstående bild för cyklonens position.
3. Vid behov kan man lyfta av tunnan från chassit.
4. Lyft ut och knyt ihop plastsäcken. Stoppa in en ny plastsäck.
5. Flytta tillbaka cyklonen på tunnan och spänn fast spännena.

Service/Underhåll

Rengöring

Vid rengöring och skötsel av maskinen ska maskinen vara avstängd och kontakten dras ur.

Filterbyte

Finfiltret ska bytas minst en gång per år. Endast original filter får användas. HEPA-filter ska bytas efter 300 timmar.



VARNING

Filterbyte får endast utföras av instruerad personal. Använd skyddsmask och lämplig utrustning.



OBSERVERA

Vid filterbyte får inga verktyg/tillhyggen användas, då dessa kan skada filtrets tätningsyta.

1. Lossa och lyft av övre delen för att få fri åtkomst till filtret.

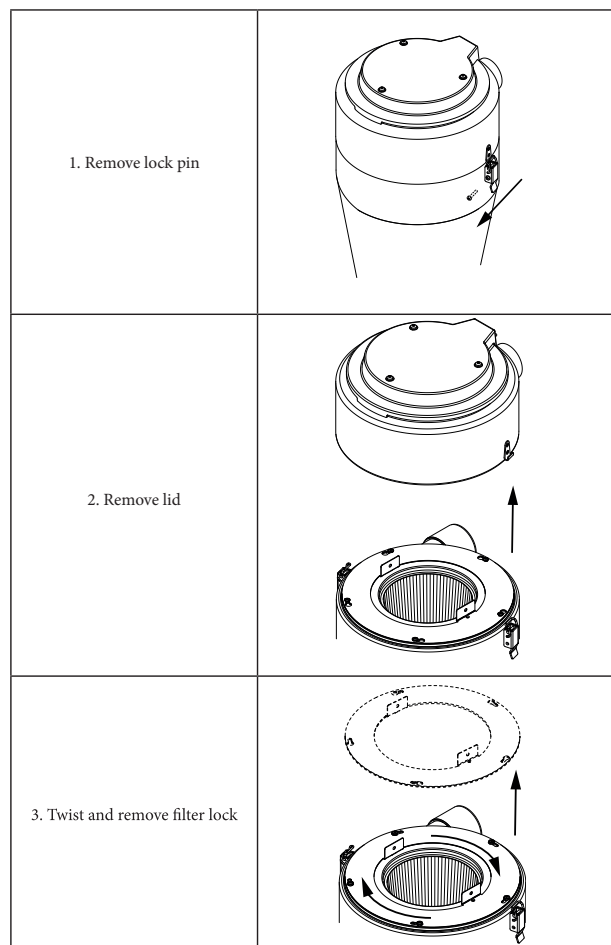

2. Trä medföljande platsäck över cyclonen för att undvika att dammet i filtret sprids.
3. Lyft filtret rakt upp.
4. Förslut platsäcken med det använda filtret.

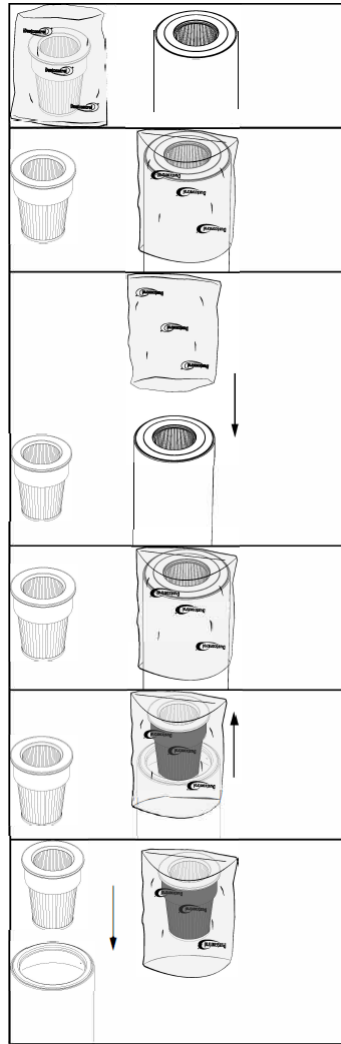

- 6.
7. Vid filterbyte kontrollera packningen.
8. En otät packning kan förorsaka utsläpp av hälsofarliga damm.
9. Använd aldrig gamla packningar eller plagiat-filter.
10. Utbyta filter ska läggas i en plastsäck som försluts.

Motor

För fläktmotorer är den typiska livslängden för originalborstar 600-700 timmar. Borsten kan bytas. För det andra borstpaketet är livslängden ca 400 timmar och för det tredje borstpaketet ca 300 timmar. Efter detta är kollektorn utsliten och motorn behöver bytas.

Överhettning

Om maskinen riskerar att blir överhettad (exempelvis genom kraftig strypning) löser temperaturvakten ut och maskinen stannar. Det är då viktigt att operatören trycker på strömbrytaren till AV-läge, drar ut sladden ur eluttaget och vänta 3-5 minuter så att maskinen hinner svalna. Därefter återställs temperaturvakt genom att trycka in knappen RESET. Återmontera sladden i eluttaget och återstarta maskinen genom att trycka på strömbrytaren till PÅ-läge.

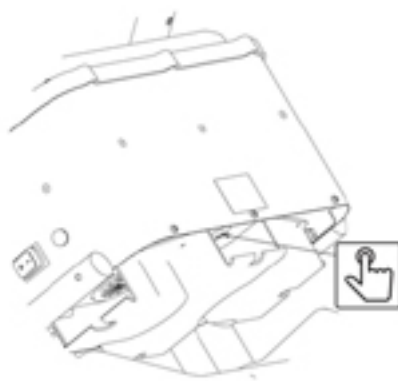

Regelbunden kontroll

Kontrollera regelbundet att elkabeln inte är skadad.

Tillbehör & Förbrukningsartiklar

Benämning	Art nr
Anslutningsmuff	2008
Anslutningsmuff	2129
Slang Ø=50	2013
HEPA-filter	44016
Finfilter polyester	44017
Plastsäck, 50 st	4314
MOTOR 1285W 230V 50/60Hz	42309-01

För reservdelar, se [Dustcontrols hemsida](#).

Garanti

Garantitiden är två år och avser fabrikationsfel. Garantin gäller under förutsättning att maskinen används på normalt sätt och får den service som krävs. Normalt slitage ersätts inte. Reparationer ska utföras av Dustcontrol eller av person som godkänts av Dustcontrol. I annat fall förverkas garantin.

Motor

Produktens motor(er) täcks inte av garantin. Exempel-livslängd för en motor kan vara mellan 600 - 700 driftstimmar. Kontakta Dustcontrol vid behov av motorbyte.

Felsökning

Problem	Orsak	Åtgärd
Motorn går inte.	El ej ansluten.	Anslut el.
Motorn stannar direkt efter start.	Felaktig säkring.	Byt till korrekt säkring.
Motorn går men maskinen suger inte.	Sugslangen inte ansluten.	Anslut slang.
Motorn går men maskinen suger dåligt.	Hål på sugslangen.	Byt slang.
	Igensatt filter.	Rensa eller byt.
	Sugslangen för lång eller smal.	Byt slang.
	Slangen delvis igensatt.	Vänd slang eller rensa.
	Maskinens topp dåligt monterad.	Justera monteringen.
Motorn stannar under drift.	Stoft har fastnat i cyklonen.	Ta bort toppen och rensa cyklonen.
	Motorn är överhettad.	Kontrollera att maskinen inte är strypt & vänta tills maskinen har kylts ner (ca 30min).
Maskinen blåser ut damm.	Filtret har lossnat eller gått sönder.	Kontrollera och byt vid behov.
Onormalt ljud från maskinen.		Beställ service.

EG-försäkran

Vi försäkrar härmed att DC Chip Extractor är i överensstämmelse med följande bestämmelser och standarder:

2006/42/EC, 2014/30/EU, 2014/35/EU, EN 60204-1:2018, EN1822-1:2019.

Dustcontrol AB



Nina Uggowitzner / CEO & Technical Manager

2024-09-30

Kontakt

Dustcontrol Worldwide

 AT
Dustcontrol Ges.m.b.H.
info@dustcontrol.at
www.dustcontrol.at

 AU
All Preparation Equipment
www.allprep.com.au

 BENELUX
Dust Solutions BV
www.dustsolutions.nl

 BG
Metaltech14 Ltd.
metaltech14@abv.bg
www.dustcontrolbg.com

 CA Dustcontrol
Canada Inc.
info@dustcontrol.ca
www.dustcontrol.ca

 CH
Rosset Technik Maschinen
Werkzeuge AG
www.rosset-technik.ch
info@rosset-technik.ch

 CL
Beckart Tecnologia Ambiental S.A.
ambitec@ambitec.cl
www.ambitec.cl

 CN
Suzhou Dustcollect Filtration
Technology Co. Ltd.
wang@dustcollect.cn
www.dustcollect.cn

 CZ / SK Ener
Group CZ, S.R.O. Infolinka:
+420 602 795 800
info@energrou.cz
www.prumysloveodsavani.cz/

 DE
Dustcontrol GmbH
info@dustcontrol.de
www.dustcontrol.de

 DK
Construction – Erenfred Pedersen A/S
info@ep.dk
www.ep.dk
Industry – Dansk Procesventilation ApS
info@dansk-procesventilation.dk
www.dansk-procesventilation.dk

 EE
G-Color Baltic OÜ
sales@g-color.ee
www.g-color.ee

 ES
Barin, s.a.
info@barin.es
www.barin.es

 GB
Dustcontrol UK Ltd.
sales@dustcontrol.co.uk
www.dustcontrol.co.uk

 GR
Mavrogiannakis S.A
ekttox@enternet.gr
www.ekttoxefis.com.gr

 FI
Dustcontrol FIN OY
dc@dustcontrol.fi
www.dustcontrol.fi

 FR
Construction – SMH Equipements
info@abequipements.com
www.smhequipements.com

Industry – Dustcontrol AB
info@dustcontrol.fra
www.dustcontrol.fra

 HR
Kermek d.o.o.
kruno.nedeljko@kermek.com
www.kermek.com

 HU
Vandras Kft
vandras@t-online.hu
www.vandras.hu

 IN
Advance Ventilation Pve Ltd.
sales@advanceventilation.com
www.advanceventilation.com

 IT
Airum srl
info@airum.com
www.airum.com

 KR
ESH Engineering Co.
eshengco@gmail.com
www.eshengco.com

 LT
UAB Hidromega
info@hidromega.lt
www.hidromega.lt

 LV
SIA Reaktivs
reaktivs@reaktivs.lv
www.reaktivs.lv

 MY, ID
Stada EnviroSpace Bhd
info@stada.com.my
www.stada.com.my

 NO
Teijo Norge A.S
firmapost@teijo.no
www.teijo.no

 NZ
Artizan Diamond Tools
enquiry@artizandiamond.co.nz
www.artizandiamond.co.nz

 PE
Efixo
contacto@efixo.pe
www.efixo.pe

 PH
Sweden Concrete Machines Inc.
peringe@packoskick.se
www.swedenconcretemachines.ph

 PL
Bart Sp. z o.o.
info@bart-vent.pl
www.bart-vent.pl

 PT
Metec-Mecano Técnica, Lda.
geral@metec.pt
www.metec.pt

 RO
AWS Elektrotehnik
office@awstehnik.ro
www.awstehnik.ro

General Contractor Industry SRL
office@gci-grup.ro
www.gci-grup.ro

 RS
Enel Alati
eneldoo@eunet.rs
www.eneldoo.rs

 RU
Centre Vacuum System
panov.g@movers-td.com
www.dustcontrolrus.ru

 SE
Dustcontrol AB
info@dustcontrol.se
www.dustcontrol.com

 SG
Stada EnviroSpace Pte Ltd
Info@stada.com.my
www.stada.com.my

 TW
Goodland Enterprise Co., Ltd.
sales@goodland.com.tw
www.goodland.com.tw

 TH
MCON Intertrade Co., Ltd.
sales@mconintertrade.com
www.mconintertrade.com

 TR Ventek
Mühendislik Ltd.
info@ventek.com.tr
www.ventek.com.tr

 AE
Global Enterprises Trading Co L.L.C.
sales@globalentco.com
www.globalentco.com

GEM
Industrial Equipment Trading Co. Tel:
+971 4 8840 474
Email: gemuae@eim.ae

 UA
MBK Obshemashkontrakt, JSC
zao@omk.dp.ua
www.omk.dp.ua

 US
Dustcontrol Inc.
info@dustcontrolusa.com
www.dustcontrol.us

 VN
Tayhostar JSC
tayhostar@tayhostar.vn
www.tayhostar.vn

Please contact the head office
in Sweden if you do not find a
distributor in your area.
info@dustcontrol.se

Legal notice



NOTICE

Translation of the original user manual



IMPORTANT

Read the user manual before using the machine.



IMPORTANT

Dustcontrol reserves the right to change specifications without notice and is under no obligation to change previously delivered products. Dustcontrol is not responsible for errors or omissions in this user manual.



IMPORTANT

All relevant state, regional and local safety regulations must be followed when installing and using this product. For safety reasons and to ensure compliance with documented system data, only the manufacturer shall carry out component repairs. Failure to follow this information may result in personal injury or equipment damage.



IMPORTANT

All rights reserved. No part of this publication may be reproduced, distributed or transmitted in any form or by any means, including photocopying, recording or other electronic or mechanical means, without the prior written permission of the publisher. For permit inquiries, contact Dustcontrol.



NOTICE

The product is manufactured by:

Dustcontrol AB
Box 3088, Kumla Gårdsväg 14
SE-145 03 Norsborg
Tel: +46 8 531 940 00
support@dustcontrol.se
www.dustcontrol.com

Safety regulations

Intro

Read the following safety instructions before starting this machine. Save the user manual. If the safety regulations are not followed, the warranty does not apply. Personal and product damage can also occur. Dustcontrol is not responsible for damage to the equipment caused by incorrect installation or incorrect handling of the equipment.

Warning

This machine is intended for professional use only.

Children should be supervised to ensure that they do not play with the machine.

Use only original accessories and consumables that are included in Dustcontrol's range.



WARNING

Use the machine for its intended purpose. Follow the instructions for the material to be extracted.



WARNING

This machine is only intended for extraction of dry material.



WARNING

When using electrical devices, basic safety instructions must be followed to reduce the risk of fire, electric shock or personal injury.



WARNING

Do not use the machine to extract hot, glowing particles or other ignitable material. Do not use the machine for explosive, unstable or self-igniting particles.



WARNING

If incorrect or non-OEM parts are used (especially filters, hoses and plastic bags), the machine can leak hazardous dust which may result in personal injury.

Environmental protection

Recycle packaging and included components according to local regulations. For more information, contact your nearest recycling center or Dustcontrol for machine scrapping.

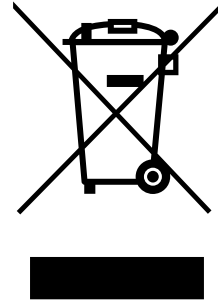
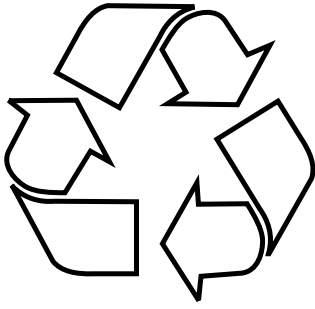

WEEE (Waste of Electric and Electronic Equipment)

Valid for EU countries only: Electrical tools must not be disposed of with household waste. Under Directive 2002/96/EC relating to older electrical and electronic equipment and its implementation in national legislation, waste electrical tools must be disposed of separately and/or recycled in an environmentally responsible manner.

Work environment

Do not expose the machine to moisture. Do not use it in damp or wet areas or close to flammable liquids or gases.



CAUTION

This machine must only be used and stored in a dry environment.



CAUTION

Do not rinse the machine with water.

Overload



CAUTION

Never let the machine work fully throttled, as this poses a risk of overheating.

Bodily injuries



WARNING

Never try to change electrical connections yourself. An error can be fatal!



WARNING

Never allow the extraction point to make contact with any part of the body. The strong negative pressure can damage blood vessels in the skin.



WARNING

Protective gloves must be worn when assembling, handling and transporting the product.

Electric cable



WARNING

Never pull the machine by the power cord. Keep the power cord away from heat and sharp objects. Regularly inspect the power cord.

If using an extension cord, it must be waterproof.

The machine must not be used if the power cords or contacts are damaged.

If the power cord is damaged, it must be replaced by Dustcontrol or a Dustcontrol authorized service center.

Important action

Turn off the main power switch and disconnect the machine from the power supply before cleaning or performing maintenance on the machine.

This machine may only be used if all filters are undamaged and correctly fitted.

Care

Keep the machine clean and free from dust deposits. Ensure that the suction hose and all seals are intact and undamaged. Keep the carrying handles dry and free from oil and grease.

Control

Regularly check the device for damage and wear. If damage occurs, these must be repaired by a Dustcontrol service technician or by a service workshop authorized by Dustcontrol.

Functional description

The dust collector works with negative pressure (suction) which drives the air through the suction hood / nozzle, hose system and pre- and dust separator. Coarse separation takes place in the unit's cyclone, which is a very efficient separation of increasingly coarser dust. The fine dust is separated in the unit's filter. Filter cleaning with air pulse gives the filters extra long life. The machine is equipped with HEPA filters.

DC Tromb 400 is used for spot extraction (with maximum throttling Ø 15 mm) in many contexts e.g. when grinding, welding, personal clean-up and cleaning. The DC Tromb 400 is powered by two 1-phase, 2-stage fans.

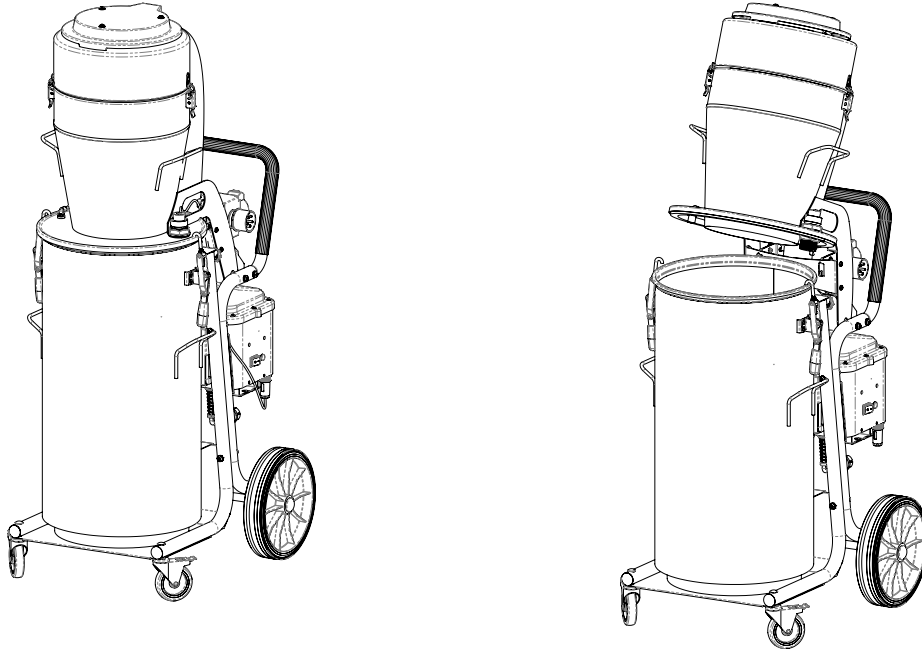

The dust collector has the following discharge option:

a - Container: A cylindrical container for collection of separated material.

Technical data

Technical data	DC Chip Extractor
HxWxL [mm]	1530 x 600 x 780
Weight [kg]	70
Inlet Ø [mm]	76
Hose length Ø50mm [m]	7.5
Collecting container [l]	90
Flow max. fan (EU) 230V [w ³ /h]	355
Negative pressure, max. [kPa]	22
Power outlet (EU) 230V [W]	2600
Fine filter, polyester, area [m ²]	1.85
Filtration efficiency, fine filter, EN 60335-2-69, Class M [%]	99.9
Filter area, HEPA filter [m ²]	2.2
Filter classification, EN 1822-1	HEPA H13
Degree of separation, machine, EN 60335-2-69, Appendix A-A, Class H [%]	99.995
Sound level [dB(A)]	70
Art. no.	174100

Operation

Connection

Connect the machine to an electrical outlet with a voltage as per the machine's rating plate specifications.

Automatic Starter (ALV10)

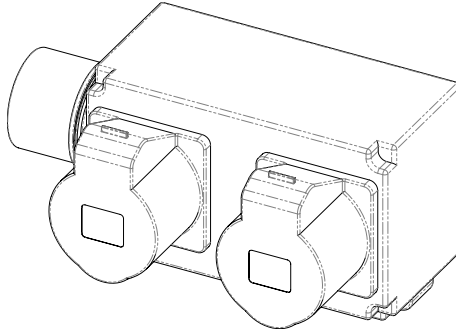

According to current safety regulations when working with woodworking machines, hazardous dust must be effectively sucked up by a chip extractor.

This starter with time delay automatically starts the chip extractor after 2-3 seconds and therefore protects against an overload on the fuse.

After the machine has been stopped, the chip vacuum continues for another 3-4 seconds and thus sucks up the remaining dust from the hoses.

Filter cleaning

The machine has a filter indicator light that lights up when the filter needs to be cleaned or replaced.

Instructions for filter cleaning

1. Leave the machine on, reset the filter cleaning button and close the damper on the cyclone inlet.
2. Wait 5-10 pulses.
3. Switch off the machine.
4. Reset the filter cleaning button and open the damper on the cyclone inlet.
5. Start the machine. Check that the filter indicator light is off. If not - repeat the procedure. If the lamp lights up even after the repetition, the fine filter needs to be replaced.



Emptying



NOTICE

Level sensors warn when the barrel is full and needs to be emptied.

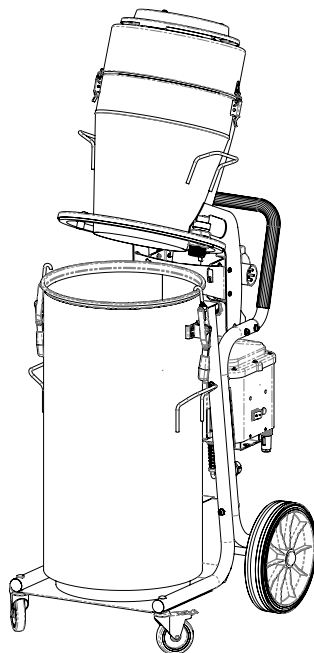

1. Loosen the clips that secure the lid to the barrel.
2. Lift the back of the cyclone using the handles on the side of the cyclone. See the above image for the cyclone's position.
3. If necessary, the barrel can be lifted from the chassis.
4. Lift out and tie the plastic bag. Insert a new plastic bag.
5. Move the cyclone back onto the barrel and tighten the buckles.

Service/Maintenance

Cleaning

The machine must be switched off and unplugged before cleaning and maintenance.

Filter replacement

The fine filter must be replaced at least once a year. Only original filters may be used. HEPA filters must be replaced after 300 hours.



WARNING

Filter replacement may only be performed by trained personnel. Use a protective mask and suitable equipment.



CAUTION

When replacing the filter, no tools/sharp objects can be used as these may damage the sealing surface of the filter.

1. Loosen and lift off the top part to gain free access to the filter.

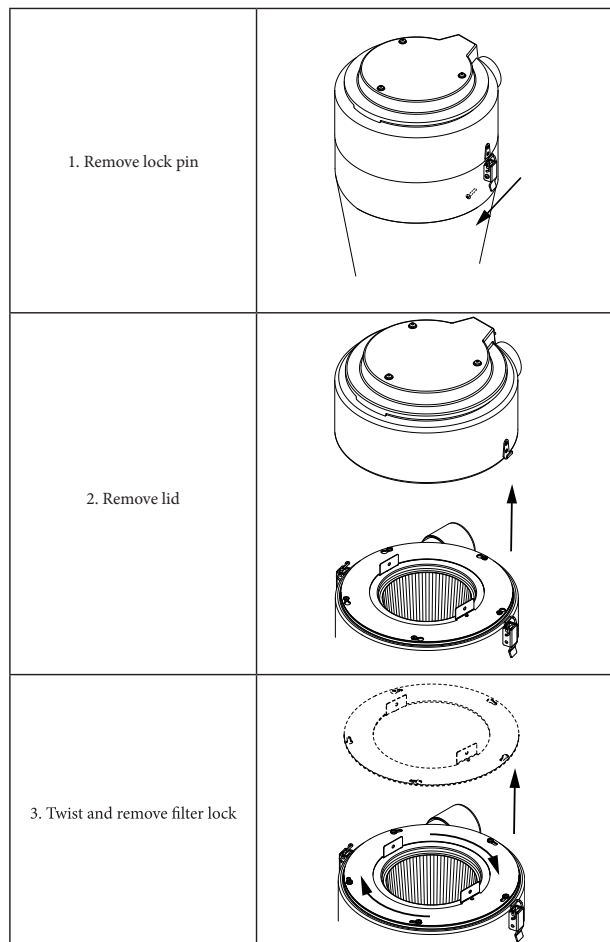

- 2.

3. Put the included plastic bag over the cyclone to prevent the dust in the filter from spreading.
4. Lift the filter straight up.
5. Seal the plastic bag with the used filter.

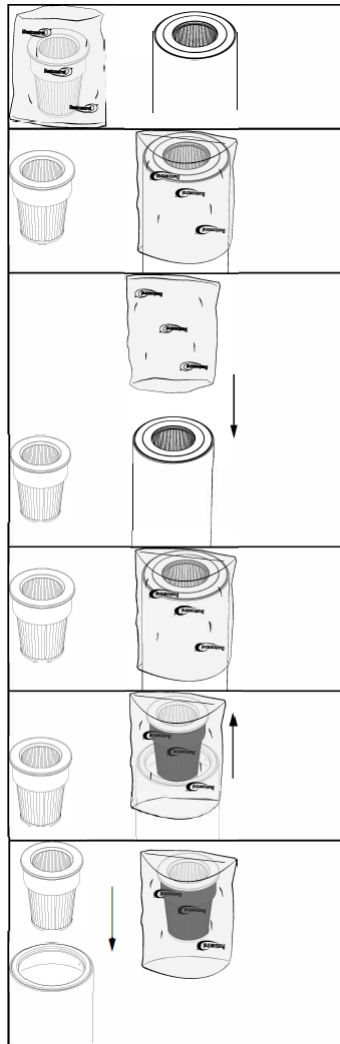

- 6.
7. When changing the filter, check the gasket.
8. A leaky gasket can cause the release of health-hazardous dust.
9. Never use old gaskets or plagiarized filters.
10. Replaced filters must be placed in a resealable plastic bag.

Motor

The typical service life of a fan motor's original brushes is 600-700 hours. The brush can be replaced. The service life of the second brush set is approx. 400 hours, while that of the third set is approx. 300 hours. After this time, the motor is considered worn out and should be replaced.

Overheating

If the machine is at risk of overheating (for example, as a result of powerful throttling), the temperature guard will trip and the machine will stop. The operator must then press the power switch to the OFF position, unplug from the mains and wait 3-5 minutes for the machine to cool down. Then reset the temperature guard by pressing the RESET button. Reconnect the power cord to the electrical outlet and restart the machine by pressing the power switch to the ON position.

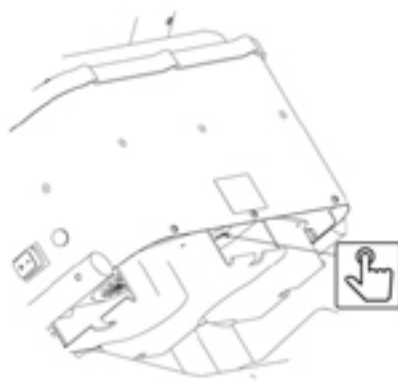

Regular check

Regularly check the power cord for damage.

Accessories & Consumables

Description	Part No.
Coupling socket	2008
Coupling socket	2129
Hose Ø=50	2013
HEPA filter	44016
Fine filter polyester	44017
Plastic bag, 50 pcs	4314
MOTOR 1285W 230V 50/60Hz	42309-01

For spare parts, see the [Dustcontrol website](#).

Warranty

The warranty period is two years and covers manufacturing defects. The warranty is valid on condition that the machine is used in the normal way and receives the required service. Normal wear and tear is not covered. Repairs must be carried out by Dustcontrol or personnel authorized by Dustcontrol. Otherwise, the warranty is void.

Engine

The engine (s) of the product are not covered by the warranty. Sample life for an engine can be between 600 - 700 operating hours. Contact Dustcontrol if you need to change the engine.

Troubleshooting

Problem	Cause	Action
Motor not running.	Power supply not connected.	Connect power supply.
Motor stops immediately after starting.	Incorrect fuse.	Replace with correct fuse.
Motor runs, but no suction.	Suction hose not connected.	Connect hose.
Motor runs, but poor suction.	Suction hose perforated.	Replace hose.
	Blocked filter.	Clean or replace.
	Suction hose too long or narrow.	Replace hose.
	Hose partially blocked.	Reverse or clean hose.
	Top of machine poorly fitted.	Adjust fitting.
The motor stops during operation.	Dust trapped in cyclone.	Remove top and clean cyclone.
	The motor is overheated.	Check that the machine is not throttled & wait until the machine has cooled down (approx. 30min).
Machine blows dust.	Filter loose or damaged.	Check and replace as necessary.
Abnormal sound from machine.		Book service.

EC Declaration of Conformity

We hereby certify that the DC Chip Extractor is in compliance with the following regulations and standards:

2006/42/EC, 2014/30/EU, 2014/35/EU, EN 60204-1:2018, EN1822-1:2019.

Dustcontrol AB



Nina Uggowitzner / CEO & Technical Manager

2024-09-30

Contact

Dustcontrol Worldwide

 **AT**
Dustcontrol Ges.m.b.H.
info@dustcontrol.at
www.dustcontrol.at

 **AU**
All Preparation Equipment
www.allprep.com.au

 **BENELUX**
Dust Solutions BV
www.dustsolutions.nl

 **BG**
Metaltech14 Ltd.
metaltech14@abv.bg
www.dustcontrolbg.com

 **CA** Dustcontrol
Canada Inc.
info@dustcontrol.ca
www.dustcontrol.ca

 **CH**
Rosset Technik Maschinen
Werkzeuge AG
info@rosset-technik.ch
www.rosset-technik.ch

 **CL**
Beckart Tecnologia Ambiental S.A.
ambitec@ambitec.cl
www.ambitec.cl

 **CN**
Suzhou Dustcollect Filtration
Technology Co. Ltd.
wang@dustcollect.cn
www.dustcollect.cn

 **CZ / SK** Ener
Group CZ, S.R.O. Infolinka:
+420 602 795 800
info@energrou.cz
www.prumysloveodsavani.cz/

 **DE**
Dustcontrol GmbH
info@dustcontrol.de
www.dustcontrol.de

 **DK**
Construction – Erenfred Pedersen A/S
info@ep.dk
www.ep.dk

Industry – Dansk Procesventilation ApS
info@dansk-procesventilation.dk
www.dansk-procesventilation.dk

 **EE**
G-Color Baltic OÜ
sales@g-color.ee
www.g-color.ee

 **ES**
Barin, s.a.
info@barin.es
www.barin.es

 **GB**
Dustcontrol UK Ltd.
sales@dustcontrol.co.uk
www.dustcontrol.co.uk

 **GR**
Mavrogiannakis S.A
ekttox@enternet.gr
www.ekttoxefits.com.gr

 **FI**
Dustcontrol FIN OY
dc@dustcontrol.fi
www.dustcontrol.fi

 **FR**
Construction – SMH Equipements
info@abequipements.com
www.smhequipements.com

Industry – Dustcontrol AB
info@dustcontrol.fra
www.dustcontrol.fra

 **HR**
Kermek d.o.o.
kruno.nedeljko@kermek.com
www.kermek.com

 **HU**
Vandras Kft
vandras@t-online.hu
www.vandras.hu

 **IN**
Advance Ventilation Pve Ltd.
sales@advanceventilation.com
www.advanceventilation.com

 **IT**
Airum srl
info@airum.com
www.airum.com

 **KR**
ESH Engineering Co.
eshengco@gmail.com
www.eshengco.com

 **LT**
UAB Hidromega
info@hidromega.lt
www.hidromega.lt

 **LV**
SIA Reaktivs
reaktivs@reaktivs.lv
www.reaktivs.lv

 **MY, ID**
Stada EnviroSpace Bhd
info@stada.com.my
www.stada.com.my

 **NO**
Teijo Norge A.S
firmapost@teijo.no
www.teijo.no

 **NZ**
Artizan Diamond Tools
enquiry@artizandiamond.co.nz
www.artizandiamond.co.nz

 **PE**
Efixo
contacto@efixo.pe
www.efixo.pe

 **PH**
Sweden Concrete Machines Inc.
peringe@packoskick.se
www.swedenconcretemachines.ph

 **PL**
Bart Sp. z o.o.
info@bart-vent.pl
www.bart-vent.pl

 **PT**
Metec-Mecano Técnica, Lda.
geral@metec.pt
www.metec.pt

 **RO**
AWS Elektrotehnik
office@awstehnik.ro
www.awstehnik.ro

General Contractor Industry SRL
office@gci-grup.ro
www.gci-grup.ro

 **RS**
Enel Alati
eneldoo@eunet.rs
www.eneldoo.rs

 **RU**
Centre Vacuum System
panov.g@movers-td.com
www.dustcontrolrus.ru

 **SE**
Dustcontrol AB
info@dustcontrol.se
www.dustcontrol.com

 **SG**
Stada EnviroSpace Pte Ltd
Info@stada.com.my
www.stada.com.my

 **TW**
Goodland Enterprise Co., Ltd.
sales@goodland.com.tw
www.goodland.com.tw

 **TH**
MCON Intertrade Co., Ltd.
sales@mconintertrade.com
www.mconintertrade.com

 **TR** Ventek
Mühendislik Ltd.
info@ventek.com.tr
www.ventek.com.tr

 **AE**
Global Enterprises Trading Co L.L.C.
sales@globalentco.com
www.globalentco.com

GEM
Industrial Equipment Trading Co. Tel:
+971 4 8840 474
Email: gemuae@eim.ae

 **UA**
MBK Obshemashkontrakt, JSC
zao@omk.dp.ua
www.omk.dp.ua

 **US**
Dustcontrol Inc.
info@dustcontrolusa.com
www.dustcontrol.us

 **VN**
Tayhostar JSC
tayhostar@tayhostar.vn
www.tayhostar.vn

Please contact the head office
in Sweden if you do not find a
distributor in your area.
info@dustcontrol.se

Rechtlicher Hinweis



HINWEIS

Übersetzung der Original-Bedienungsanleitung



WICHTIG

Lesen Sie die Bedienungsanleitung, bevor Sie die Maschine verwenden.



WICHTIG

Dustcontrol behält sich das Recht vor, Spezifikationen ohne Vorankündigung zu ändern und ist nicht verpflichtet, bereits gelieferte Produkte zu ändern. Dustcontrol übernimmt keine Verantwortung für Fehler oder Auslassungen in dieser Bedienungsanleitung.



WICHTIG

Bei der Installation und Verwendung dieses Produkts müssen alle relevanten staatlichen, regionalen und lokalen Sicherheitsvorschriften befolgt werden. Aus Sicherheitsgründen und zur Sicherstellung der Einhaltung dokumentierter Anlagendaten sollte die Reparatur von Komponenten ausschließlich vom Hersteller durchgeführt werden. Die Nichtbeachtung dieser Informationen kann zu Verletzungen oder Sachschäden führen.



WICHTIG

Alle Rechte vorbehalten. Kein Teil dieser Veröffentlichung darf ohne vorherige schriftliche Genehmigung des Herausgebers in irgendeiner Form oder mit irgendwelchen Mitteln, einschließlich Fotokopie, Aufzeichnung oder anderen elektronischen oder mechanischen Mitteln, reproduziert, verbreitet oder übertragen werden. Für Genehmigungsanfragen wenden Sie sich bitte an Dustcontrol.



HINWEIS

Das Produkt wird hergestellt von:

Dustcontrol AB
Box 3088, Kumla Gårdsväg 14
SE-145 03 Norsborg
Tel: +46 8 531 940 00
support@dustcontrol.se
www.dustcontrol.com

Sicherheitsvorschriften

Einführung

Lesen Sie die folgenden Sicherheitshinweise, bevor Sie diese Maschine starten. Bewahren Sie die Bedienungsanleitung auf. Bei Nichtbeachtung der Sicherheitsvorschriften entfällt die Gewährleistung. Auch Personen- und Produktschäden können auftreten. Dustcontrol haftet nicht für Schäden an der Ausrüstung, die durch falsche Installation oder falsche Handhabung der Ausrüstung verursacht werden.

Warnung

Diese Maschine ist nur für den professionellen Gebrauch bestimmt.

Kinder müssen beaufsichtigt werden, um sicherzustellen, dass sie nicht mit der Maschine spielen.

Verwenden Sie nur Originalzubehör und Verbrauchsmaterialien, die im Sortiment von Dustcontrol enthalten sind.



WARNUNG

Verwenden Sie die Maschine für den vorgesehenen Zweck. Befolgen Sie die Vorschriften für das abzusaugende Material.



WARNUNG

Diese Maschine ist ausschließlich für das Absaugen von trockenem Material vorgesehen.



WARNUNG

Bei der Verwendung elektrischer Geräte sind die grundsätzlichen Sicherheitsvorkehrungen zu befolgen, damit die Gefahr von Brand, Elektroschocks oder Verletzungen minimiert wird.



WARNUNG

Es dürfen keine heißen, glühenden Partikel oder sonstige Zündquellen in die Maschine gesaugt werden. Die Maschine darf nicht für explosive, instabile oder selbstzündende Partikel benutzt werden.



WARNUNG

Bei der Verwendung von fehlerhaften Artikeln oder Nicht-Originalteilen (vor allem Filter, Schläuche und Plastiksäcke) kann gesundheitsschädlicher Staub aus der Maschine austreten, und Sie gefährden Ihre Gesundheit.

Umweltschutz

Recyceln Sie die Verpackung und die enthaltenen Komponenten gemäß den örtlichen Vorschriften. Für weitere Informationen wenden Sie sich an Ihr nächstgelegenes Recyclingzentrum oder an Dustcontrol für die Maschinenverschrottung.

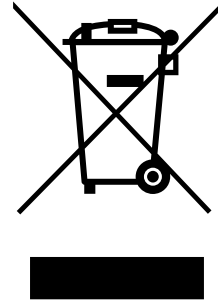
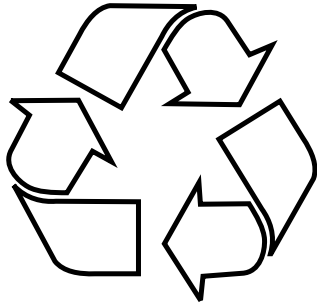

WEEE (Abfall von Elektro- und Elektronik- Altgeräte)

Gilt nur für EU-Länder: Elektrowerkzeuge dürfen nicht im Hausmüll entsorgt werden. Gemäß Richtlinie 2002/96/EG für älteren Elektro- und Elektronikgeräten und ihrer Verwendung nach nationalem Recht muss ausgedientes Elektrowerkzeug separat aussortiert und einem umweltverträglichen Recycling zugeführt werden.

Arbeitsumfeld

Die Maschine darf nicht in feuchten und nassen Bereichen oder in der Nähe von leicht entzündlichen Flüssigkeiten oder Gasen benutzt werden.



ACHTUNG

Diese Maschine darf nur in trockener Umgebung eingesetzt und aufbewahrt werden.



ACHTUNG

Die Maschine darf nicht mit Wasser abgespült werden.

Überlast



ACHTUNG

Die Maschine darf niemals voll gedrosselt laufen, weil dann Überhitzungsgefahr besteht.

Körperverletzungen



WARNUNG

Versuchen Sie niemals, elektrische Verbindungen eigenmächtig zu ändern. Ein Fehler kann Lebensgefahr bedeuten!



WARNUNG

Ansaugöffnungen dürfen niemals mit einem Körperteil in Berührung kommen. Der starke Unterdruck kann die Blutgefäße der Haut verletzen.



WARNUNG

Bei der Montage, Handhabung und dem Transport des Produkts sind Schutzhandschuhe zu tragen.

Stromkabel



WARNUNG

Ziehen Sie die Maschine niemals am Stromkabel. Setzen Sie das Kabel weder Hitze noch scharfen Gegenständen aus. Überprüfen Sie das Kabel regelmäßig.

Beim verlängern des Netzkabels muss das verlängerungskabel wasserdicht sein.

Die Maschine darf nicht zum Einsatz kommen, wenn die Kabel oder Kontakte beschädigt sind.

Ist das Kabel beschädigt, muss es von Dustcontrol oder einer von Dustcontrol autorisierten Servicewerkstatt ausgetauscht werden.

Wichtige Aktion

Schalten Sie den Hauptschalter ab und nehmen Sie die Maschine vom Netz, bevor Sie sie reinigen bzw. Wartungsarbeiten ausführen.

Diese Maschine darf nur verwendet werden, wenn alle Filter unbeschädigt und korrekt montiert sind.

Pflege

Halten Sie die Maschine sauber und frei von Staubablagerungen. Achten Sie darauf, dass der Saugschlauch intakt ist, dass alle Dichtungen unbeschädigt und einwandfrei in Ordnung sind. Die Tragegriffe müssen stets trocken und frei von Öl und Fett sein.

Kontrolle

Es ist regelmäßig sicherzustellen, dass die Maschine weder beschädigt ist noch Verschleiß aufweist. Eventuelle Schäden sind von einem Dustcontrol-Kundendiensttechniker oder einer offiziellen Dustcontrol-Kundendienstwerkstatt zu beheben.

Funktionsbeschreibung

Der Staubabscheider arbeitet mit Unterdruck (Saug), der die Luft durch den Saugdeckel/Düse, das Schlauchsystem und den Vor- und Staubabscheider treibt. Im Zyklon der Anlage erfolgt eine Grobabscheidung, die eine sehr effektive Abscheidung zunehmend größerer Stäube ermöglicht. Der Feinstaub wird im Filter des Gerätes abgeschieden. Die Filterreinigung mit Luftimpuls verleiht den Filtern eine besonders lange Lebensdauer. Die Maschine ist mit einem HEPA-Filter ausgestattet.

DC Tromb 400 wird zur örtlichen Absaugung (mit max. Absaugdurchmesser-Ø 15 mm) in verschiedensten Zusammenhängen, beispielsweise zum Schleifen, Schweißen, zur manuellen Sanierung und Reinigung, eingesetzt. DC Tromb 400 wird von zwei einphasigen Zweistufengebläsen betrieben.

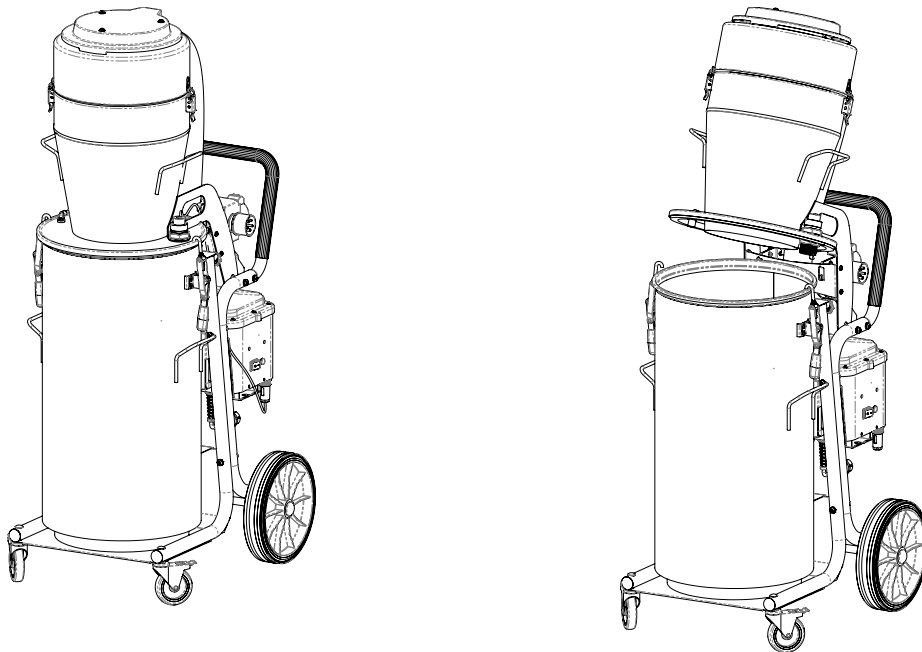

Der Staubabscheider hat folgende Austragsmöglichkeiten:

a- Behälter: Ein zylindrischer Behälter für die Aufnahme von abgeschiedenem Material. Mit innenliegendem Plastiksack.

Technische Daten

Technische Daten	DC Chip Extractor
HxBxL [mm]	1530 x 600 x 780
Gewicht [kg]	70
Einlass-Ø [mm]	76
Schlauchlänge Ø50mm [m]	7.5
Sammelbehälter [l]	90
Durchfluss max. Ventilator (EU) 230V [m ³ /H]	355
Unterdruck max. [kPa]	22
Steckdose (EU) 230V [W]	2600
Feinfilter, Polyester, Fläche [m ²]	1.85
Feinfilter mit Trenngrad, EN 60335-2-69, Klasse M [%]	99.9
Filterfläche, Mikrofilter [m ²]	2.2
Filterklassifizierung, EN 1822-1 Mikrofilter	HEPA H13
Abscheidegrad Maschine, EN 60335-2-69, Anlage A-A, Klasse H [%]	99.995
Schallpegel [dB(A)]	70
Art.-Nr.	174100

Betrieb

Anschließen

Die Maschine wird an eine Steckdose mit Spannung nach den Angaben auf dem Maschinentypenschild angeschlossen.

Automatischer Starter (ALV10)

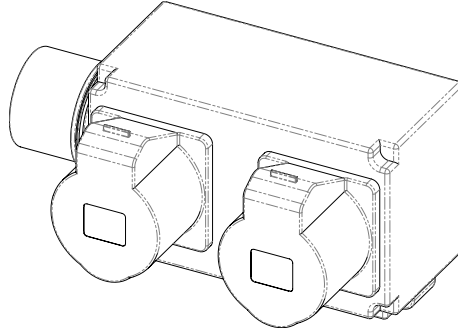

Gemäß den aktuellen Sicherheitsvorschriften beim Arbeiten mit Holzbearbeitungsmaschinen müssen gefährliche Stäube durch einen Späneabsauger wirksam abgesaugt werden.

Dieser Starter mit Zeitverzögerung startet die Spanabsaugung automatisch nach 2-3 Sekunden und schützt so vor einer Überlastung der Sicherung.

Nachdem die Maschine gestoppt wurde, läuft der Spänesauger noch 3-4 Sekunden weiter und saugt so den restlichen Staub aus den Schläuchen.

Filterreinigung

Die Maschine verfügt über eine Filterkontrollleuchte, die aufleuchtet, wenn der Filter gereinigt oder ausgetauscht werden muss.

Anleitung zur Filterreinigung

1. Lassen Sie die Maschine eingeschaltet, stellen Sie den Filterreinigungsknopf zurück und schließen Sie die Klappe am Zykloneinlass.
2. Warten Sie 5-10 Impulse.
3. Schalten Sie die Maschine aus.
4. Setzen Sie die Filterreinigungstaste zurück und öffnen Sie die Klappe am Zykloneinlass.
5. Starten Sie die Maschine. Überprüfen Sie, ob die Filterkontrollleuchte aus ist. Wenn nicht, wiederholen Sie den Vorgang. Leuchtet die Lampe auch nach der Wiederholung auf, muss der Feinfilter ausgetauscht werden.



Leeren



HINWEIS

Füllstandssensoren warnen, wenn das Fass voll ist und geleert werden muss.

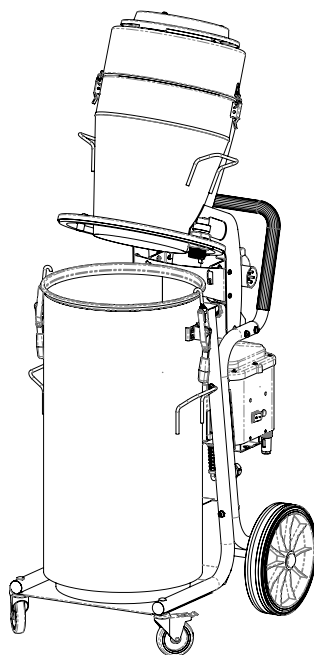

1. Lösen Sie die Clips, mit denen der Deckel am Fass befestigt ist.
2. Heben Sie die Rückseite des Zyklons mithilfe der Griffe an der Seite des Zyklons an. Die Position des Zyklons finden Sie im Bild oben.
3. Bei Bedarf kann der Lauf vom Chassis abgehoben werden.
4. Heben Sie die Plastiktüte heraus und binden Sie sie zu. Legen Sie eine neue Plastiktüte ein.
5. Bewegen Sie den Zyklon zurück auf den Lauf und ziehen Sie die Schnallen fest.

Service/Wartung

Reinigung

Bei der Reinigung und Wartung der Maschine muss die Maschine ausgeschaltet und der Netzstecker gezogen sein.

Filterwechsel

Der Feinfilter sollte mindestens einmal im Jahr gewechselt werden. Es dürfen nur Originalfilter verwendet werden. Die Mikrofilter müssen nach 300 Stunden ausgetauscht werden.



WARNUNG

Der Filterwechsel darf nur von geschultem Personal vorgenommen werden. Schutzmaske und geeignete Ausrüstung tragen.



ACHTUNG

Beim Filterwechsel dürfen weder Werkzeug noch spitze Gegenstände verwendet werden, da diese die Dichtungsfläche des Filters beschädigen können.

1. Lösen und heben Sie das Oberteil ab, um freien Zugang zum Filter zu erhalten.

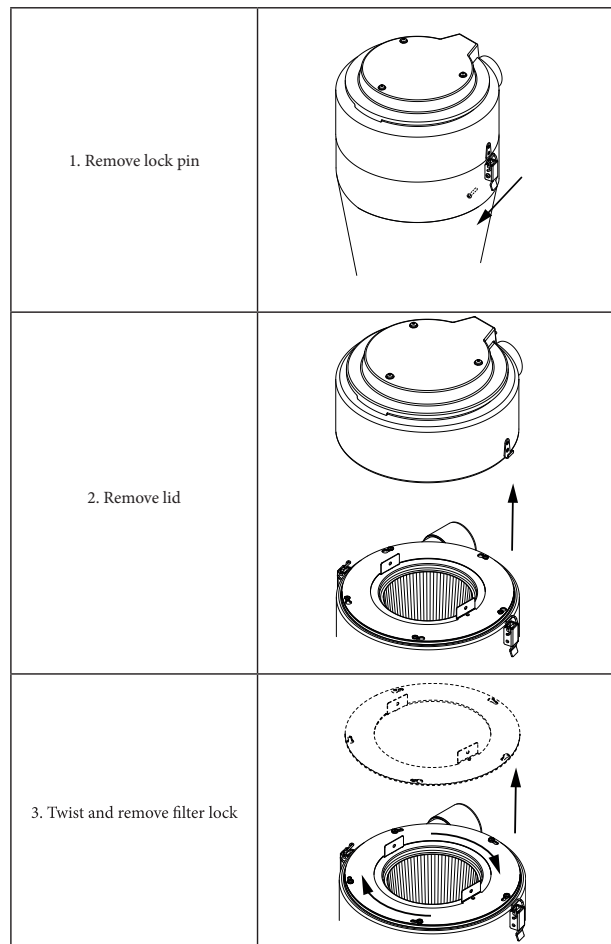

- 2.
3. Stülpen Sie die mit dem neuen Filter mitgelieferte Plastiktüte über den Zyklon.
4. Heben Sie den Filter gerade nach oben.
5. Verschließen Sie den Plastikbeutel mit dem gebrauchten Filter.

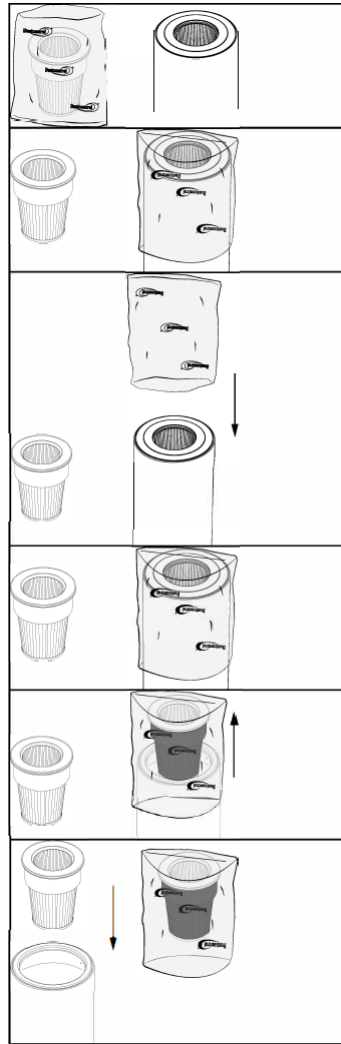

- 6.
7. Überprüfen Sie beim Filterwechsel die Dichtung.
8. Durch eine undichte Dichtung kann gesundheitsgefährdender Staub freigesetzt werden.
9. Verwenden Sie niemals alte Dichtungen oder Plagiate von Filtern.
10. Ausgetauschte Filter müssen in einem Plastikbeutel ordnungsgemäß entsorgt werden.

Motor

Für Kollektormotoren beträgt die typische Nutzlebensdauer der Originalbürsten 600-700 Stunden. Die Bürsten sind austauschbar. Für das zweite Bürstenpaket beträgt die Nutzlebensdauer ca. 400 Stunden, und für das dritte Bürstenpaket ca. 300 Stunden. Danach ist der Kollektor verschlissen, und der Motor muss ausgetauscht werden.

Überhitzung

Wenn die Gefahr besteht, dass sich die Maschine überhitzt (z.B. durch starke Drosselung), löst der Temperatursensor aus, und die Maschine hält an. Jetzt ist es ganz wichtig, dass der Bediener den Schalter auf AUS stellt, den Stecker abzieht und 3-5 Minuten wartet, damit die Maschine abkühlen kann. Danach wird der Temperatursensor zurückgesetzt, dazu wird die Reset-Taste betätigt. Anschließend den Stecker wieder einstecken und die Maschine wieder einschalten. Hierzu den Schalter auf EIN stellen.

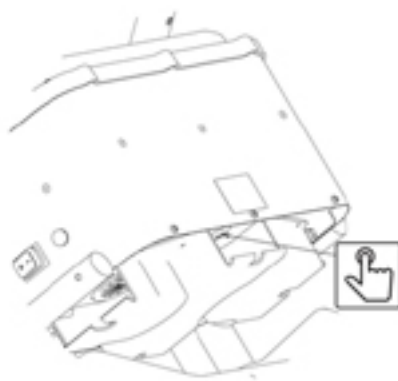

Regelmäßige Kontrolle

Überprüfen Sie regelmäßig, ob das Stromkabel intakt ist.

Zubehör und Verbrauchsmaterialien

Bezeichnung	Art.-Nr.
Anschlussmuffe	2008
Anschlussmuffe	2129
Schlauch Ø = 50	2013
HEPA-Filter	44016
Feinfilterpolyester	44017
Plastiksack, 50 Stück	4314
MOTOR 1285W 230V 50/60Hz	42309-01

Ersatzteile finden Sie auf [Dustcontrols Website](#).

Gewährleistung

Die Gewährleistungsfrist beträgt zwei Jahre und bezieht sich auf Herstellungsmängel. Die Gewährleistung gilt, wenn die Maschine vorschriftsmäßig eingesetzt und gewartet wird. Normaler Verschleiß wird nicht ersetzt. Reparaturen sind von Dustcontrol oder einer von Dustcontrol autorisierten Person durchzuführen. Andernfalls verfällt die Gewährleistung.

Motor

Der/die Motor(en) des Produkts fallen nicht unter die Garantie. Die Lebensdauer eines Motors kann zwischen 600 und 700 Betriebsstunden betragen. Wenden Sie sich an Dustcontrol, wenn Sie den Motor wechseln müssen.

Fehlersuche und -behebung

Problem	Ursache	Maßnahme
Der Motor läuft nicht.	Nicht ans Stromnetz angeschlossen.	Ans Netz anschließen.
Der Motor stoppt unmittelbar nach dem Start.	Defekte Sicherung.	Gegen eine funktionstüchtige Sicherung austauschen.
Der Motor läuft, aber die Maschine saugt nicht.	Der Saugschlauch ist nicht angeschlossen.	Den Schlauch anschließen.
Der Motor läuft, aber die Maschine saugt schlecht.	Löcher im Saugschlauch.	Schlauch austauschen.
	Verstopfter Filter.	Reinigen oder austauschen.
	Saugschlauch zu lang oder zu dünn.	Schlauch austauschen.
	Schlauch teilweise verstopft.	Den Schlauch umgekehrt einsetzen und freisangen oder reinigen.
	Oberteil der Maschine ist mangelhaft montiert.	Einbau ändern.
	Staub hat sich im Zyklon festgesetzt.	Oberteil abnehmen und Zyklon reinigen.
Der Motor stoppt während des Betriebs.	Der Motor ist überhitzt.	Prüfen Sie, dass die Maschine nicht gedrosselt ist & warten Sie, bis die Maschine abgekühlt ist (ca. 30min).
Staub entweicht aus der Maschine.	Der Filter sitzt lose oder ist defekt.	Überprüfen und ggf. austauschen.
Unnormale Geräusche von der Maschine.		Kundendienst anfordern.

EG-Konformitätserklärung

Hiermit bestätigen wir, dass der DC Chip Extractor den folgenden Vorschriften und Standards entspricht:

2006/42/EC, 2014/30/EU, 2014/35/EU, EN 60204-1:2018, EN1822-1:2019.

Dustcontrol AB



Nina Uggowitzer / CEO & Technical Manager

2024-09-30

Kontakt

Dustcontrol Worldwide



AT
Dustcontrol Ges.m.b.H.
info@dustcontrol.at
www.dustcontrol.at



AU
All Preparation Equipment
www.allprep.com.au



BENELUX
Dust Solutions BV
www.dustsolutions.nl



BG
Metaltech14 Ltd.
metaltech14@abv.bg
www.dustcontrolbg.com



CA Dustcontrol
Canada Inc.
info@dustcontrol.ca
www.dustcontrol.ca



CH
Rosset Technik Maschinen
Werkzeuge AG
info@rosset-technik.ch
www.rosset-technik.ch



CL
Beckart Tecnologia Ambiental S.A.
ambitec@ambitec.cl
www.ambitec.cl



CN
Suzhou Dustcollect Filtration
Technology Co. Ltd.
wang@dustcollect.cn
www.dustcollect.cn



CZ / SK Ener
Group CZ, S.R.O. Infolinka:
+420 602 795 800
info@energrou.cz
www.prumysloveodsavani.cz/



DE
Dustcontrol GmbH
info@dustcontrol.de
www.dustcontrol.de



DK
Construction – Erenfred Pedersen A/S
info@ep.dk
www.ep.dk

Industry – Dansk Procesventilation ApS
info@dansk-procesventilation.dk
www.dansk-procesventilation.dk



EE
G-Color Baltic OÜ
sales@g-color.ee
www.g-color.ee



ES
Barin, s.a.
info@barin.es
www.barin.es



GB
Dustcontrol UK Ltd.
sales@dustcontrol.co.uk
www.dustcontrol.co.uk



GR
Mavrogiannakis S.A
ekttox@enternet.gr
www.ekttoxefis.com.gr



FI
Dustcontrol FIN OY
dc@dustcontrol.fi
www.dustcontrol.fi



FR
Construction – SMH Equipements
info@abequipements.com
www.smhequipements.com



Industry – Dustcontrol AB
info@dustcontrol.fra
www.dustcontrol.fra



HR
Kermek d.o.o.
kruno.nedeljko@kermek.com
www.kermek.com



HU
Vandras Kft
vandras@t-online.hu
www.vandras.hu



IN
Advance Ventilation Pve Ltd.
sales@advanceventilation.com
www.advanceventilation.com



IT
Airum srl
info@airum.com
www.airum.com



KR
ESH Engineering Co.
eshengco@gmail.com
www.eshengco.com



LT
UAB Hidromega
info@hidromega.lt
www.hidromega.lt



LV
SIA Reaktivs
reaktivs@reaktivs.lv
www.reaktivs.lv



MY, ID
Städa EnviroSPACE Bhd
info@stada.com.my
www.stada.com.my



NO
Teijo Norge A.S
firmapost@teijo.no
www.teijo.no



NZ
Artizan Diamond Tools
enquiry@artizandiamond.co.nz
www.artizandiamond.co.nz



PE
Efixo
contacto@efixo.pe
www.efixo.pe



PH
Sweden Concrete Machines Inc.
peringe@packoskick.se
www.swedenconcretemachines.ph



PL
Bart Sp. z o.o.
info@bart-vent.pl
www.bart-vent.pl



PT
Metec-Mecano Técnica, Lda.
geral@metec.pt
www.metec.pt



RO
AWS Elektrotehnik
office@awstehnik.ro
www.awstehnik.ro



General Contractor Industry SRL
office@gci-grup.ro
www.gci-grup.ro



RS
Enel Alati
eneldoo@eunet.rs
www.eneldoo.rs



RU
Centre Vacuum System
panov.g@movers-td.com
www.dustcontrolrus.ru



SE
Dustcontrol AB
info@dustcontrol.se
www.dustcontrol.com



SG
Städa EnviroSPACE Pte Ltd
Info@stada.com.my
www.stada.com.my



TW
Goodland Enterprise Co., Ltd.
sales@goodland.com.tw
www.goodland.com.tw



TH
MCON Intertrade Co., Ltd.
sales@mconintertrade.com
www.mconintertrade.com



TR Ventek
Mühendislik Ltd.
info@ventek.com.tr
www.ventek.com.tr



AE
Global Enterprises Trading Co L.L.C.
sales@globalentco.com
www.globalentco.com



GEM
Industrial Equipment Trading Co. Tel:
+971 4 8840 474
Email: gemuae@eim.ae



UA
MBK Obshemashkontrakt, JSC
zao@omk.dp.ua
www.omk.dp.ua



US
Dustcontrol Inc.
info@dustcontrolusa.com
www.dustcontrol.us



VN
Tayhostar JSC
tayhostar@tayhostar.vn
www.tayhostar.vn

Please contact the head office
in Sweden if you do not find a
distributor in your area.
info@dustcontrol.se

Aviso legal



AVISO

Traducción del manual de usuario original



IMPORTANTE

Lea el manual de usuario antes de utilizar la máquina.



IMPORTANTE

Dustcontrol se reserva el derecho de cambiar las especificaciones sin previo aviso y no tiene ninguna obligación de cambiar los productos entregados anteriormente. Dustcontrol no es responsable de los errores u omisiones en este manual del usuario.



IMPORTANTE

Se deben seguir todas las normas de seguridad estatales, regionales y locales pertinentes al instalar y utilizar este producto. Por razones de seguridad y para garantizar el cumplimiento de los datos documentados del sistema, sólo el fabricante deberá realizar las reparaciones de los componentes. El incumplimiento de esta información puede provocar lesiones personales o daños al equipo.



IMPORTANTE

Reservados todos los derechos. Ninguna parte de esta publicación puede reproducirse, distribuirse o transmitirse de ninguna forma ni por ningún medio, incluidas fotocopias, grabaciones u otros medios electrónicos o mecánicos, sin el permiso previo por escrito del editor. Para consultas sobre permisos, comuníquese con Dustcontrol.



AVISO

El producto es fabricado por:

Dustcontrol AB
Box 3088, Kumla Gårdsväg 14
SE-145 03 Norsborg
Tel: +46 8 531 940 00
support@dustcontrol.se
www.dustcontrol.com

Normas de seguridad

Introducción

Lea las siguientes instrucciones de seguridad antes de poner en marcha esta máquina. Guarde el manual de usuario. Si no se siguen las normas de seguridad, la garantía no se aplica. También pueden ocurrir daños personales y al producto. Dustcontrol no se hace responsable de los daños al equipo causados por una instalación incorrecta o un manejo incorrecto del equipo.

Advertencia

Esta máquina está destinada únicamente a uso profesional.

Los niños deben ser supervisados para asegurarse de que no jueguen con la máquina.

Utilice solo accesorios y consumibles originales que se incluyen en la gama de Dustcontrol.



AVISO

Utilice la máquina para el objetivo para el que está prevista. Siga las instrucciones para el material que se aspira.



AVISO

Esta máquina está diseñada solo para aspirar material seco.



AVISO

Cuando se utilicen dispositivos eléctricos, se deben seguir las indicaciones de seguridad básicas de seguridad para reducir el riesgo de incendio, descarga eléctrica o lesiones personales.



AVISO

En la máquina no se debe aspirar ninguna partícula caliente o incandescente ni ninguna otra fuente de ignición. La máquina no se debe utilizar para partículas explosivas, inestables o de combustión espontánea.



AVISO

Si se utilizan artículos defectuosos o falsificados (sobre todo filtros, mangueras y bolsas de plástico), la máquina puede filtrar polvo nocivo y ello puede provocar lesiones personales.

Protección ambiental

Recicle el embalaje y los componentes incluidos de acuerdo con las normativas locales. Para obtener más información, comuníquese con su centro de reciclaje más cercano o con Dustcontrol para el desguace de la máquina.

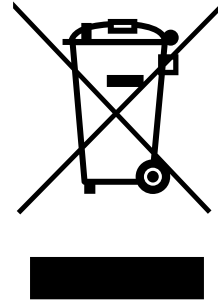
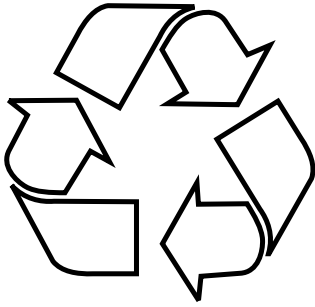

RAEE (Residuos de aparatos eléctricos y electrónicos)

Solo se aplica a los países de la UE: Las herramientas eléctricas no deben desecharse junto con los residuos domésticos. En virtud de la Directiva 2002/96/CE relativa a los aparatos eléctricos y electrónicos más antiguos y su adecuación según la legislación nacional, las herramientas eléctricas al final de su vida útil se deben clasificar por separado y dejarse en lugares en los que se realice un reciclaje respetuoso con el medio ambiente.

Ambiente de trabajo

No exponga la máquina a la humedad. No la utilice en espacios húmedos o mojados o cerca de líquidos o gases inflamables.



ATENCIÓN

Esta máquina solo se debe utilizar y guardar en un ambiente seco.



ATENCIÓN

No se debe enjuagar la máquina con agua.

Sobrecarga



ATENCIÓN

No permita nunca que la máquina funcione ahogada, ya que esto representa un riesgo de sobrecalentamiento.

Lesiones corporales



AVISO

No intente nunca cambiar las conexiones eléctricas usted mismo. ¡Un error puede ser letal!



AVISO

No deje nunca que el punto de aspiración entre en contacto con ninguna parte del cuerpo. La fuerte presión negativa puede dañar los vasos sanguíneos de la piel.



AVISO

Deben usarse guantes protectores durante el montaje, la manipulación y el transporte del producto.

cable electrico



AVISO

No arrastre nunca la máquina tirando del cable de alimentación. No exponga el cable de alimentación al calor ni a objetos afilados. Compruebe el cable de alimentación con regularidad.

Al empalmar el cable de alimentación, el alargador debe ser estanco.

La máquina no se debe utilizar si los cables de alimentación o los contactos están dañados.

Si el cable de alimentación está dañado, debe ser sustituido por Dustcontrol o un taller de servicio autorizado por Dustcontrol.

Acción importante

Apague el interruptor de alimentación principal y desconecte la máquina de la fuente de alimentación antes de limpiar o realizar ninguna actividad de mantenimiento en la máquina.

Esta máquina sólo se puede utilizar si todos los filtros no están dañados y están correctamente instalados.

Cuidado

Mantenga la máquina limpia y libre de depósitos de polvo. Asegúrese de que la manguera de aspiración esté entera y de que todas las juntas de estanqueidad estén intactas y sin defectos. Mantenga las asas de transporte secas y libres de aceite y grasa.

Control

Compruebe periódicamente que la unidad no tiene daños ni desgaste. En caso de aparecer daños, los deben subsanar los técnicos de servicio de Dustcontrol o un taller de servicio autorizado por Dustcontrol.

Descripción de las funciones

El colector de polvo funciona con presión negativa (succión) que impulsa el aire a través de la campana/boquilla de succión, el sistema de mangueras y el separador de polvo y previo. La separación gruesa se lleva a cabo en el ciclón de la unidad, que es una separación muy eficiente de polvo cada vez más grueso. El polvo fino se separa en el filtro de la unidad. La limpieza del filtro con pulsos de aire les da a los filtros una vida extra larga. La máquina está equipada con filtros HEPA.

El DC Tromb 400 se utiliza para la aspiración en orificios (con una estrangulación máxima de \varnothing 15 mm) en muchas situaciones, por ejemplo, durante el amolado, la soldadura, la rehabilitación personal y la limpieza. El DC Tromb 400 está accionado por dos ventiladores monofásicos de dos etapas.

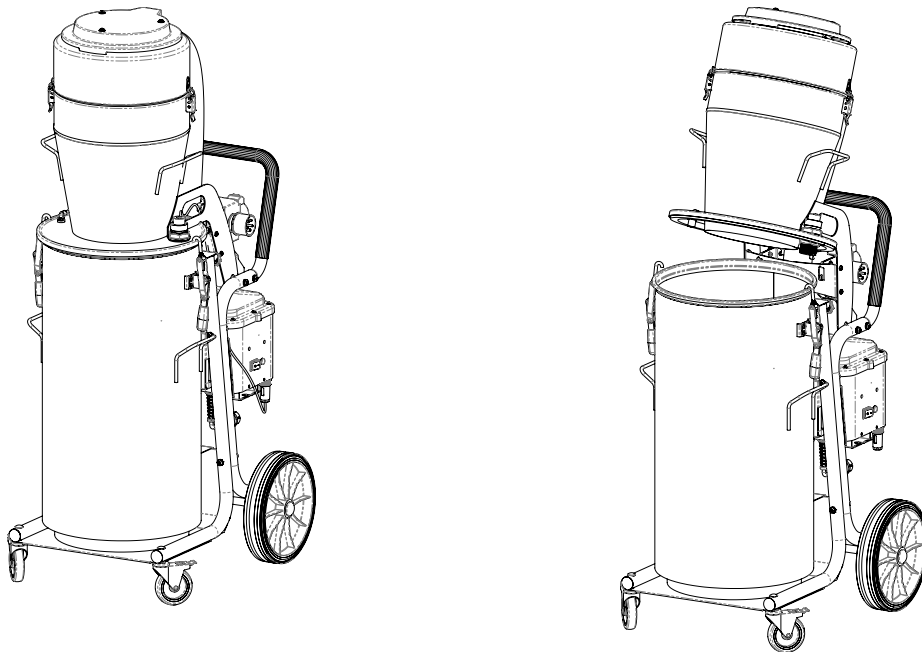

El colector de polvo tiene la siguiente opción de descarga:

a- Depósito: Un depósito cilíndrico para la recogida del material separado.

Datos técnicos

Datos técnicos	DC Chip Extractor
HxAxF [mm]	1530 x 600 x 780
Peso [kg]	70
Ø entrada [mm]	76
Longitud de la manguera Ø50 [m]	7.5
Capacidad contenedor [l]	90
Flujo máx. ventilador (UE) 230V [w ³ /h]	355
Presión negativa Max. [kPa]	22
Toma de corriente (UE) 230V [W]	2600
Filtro fino poliéster, superficie [m ²]	1.85
Grado separación filtro fino, EN 60335-2-69, clase M [%]	99.9
Superficie microfiltro[m ²]	2.2
Clasificación del filtro, EN 1822-1	HEPA H13
Máquina de grado de separación, EN 60335-2-69, Anexo A-A, Clase H [%]	99.995
Nivel de ruido [dB(A)]	70
N.º de artículo	174100

Operación

Conexión

Conecte la máquina a una toma de corriente con tensión según las especificaciones de la placa de identificación de la máquina.

Arrancador automático (ALV10)

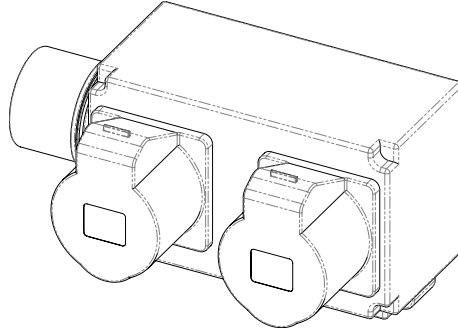

Según las normas de seguridad vigentes al trabajar con máquinas para trabajar la madera, un aspirador de virutas debe aspirar eficazmente el polvo peligroso.

Este arrancador con retardo de tiempo inicia automáticamente el extractor de virutas después de 2-3 segundos y, por lo tanto, protege contra una sobrecarga en el fusible.

Una vez parada la máquina, la aspiración de virutas continúa durante otros 3-4 segundos y así aspira el polvo restante de las mangueras.

Limpieza de filtros

La máquina tiene una luz indicadora de filtro que se enciende cuando es necesario limpiar o reemplazar el filtro.

Instrucciones para la limpieza del filtro.

1. Deje la máquina encendida, reinicie el botón de limpieza del filtro y cierre la compuerta en la entrada del ciclón.
2. Espere de 5 a 10 pulsos.
3. Apague la máquina.
4. Reinicie el botón de limpieza del filtro y abra la compuerta en la entrada del ciclón.
5. Inicie la máquina. Compruebe que la luz indicadora del filtro esté apagada. Si no, repita el procedimiento. Si la lámpara se enciende incluso después de la repetición, es necesario reemplazar el filtro fino.



Drenar



AVISO

Los sensores de nivel avisan cuando el barril está lleno y es necesario vaciarlo.

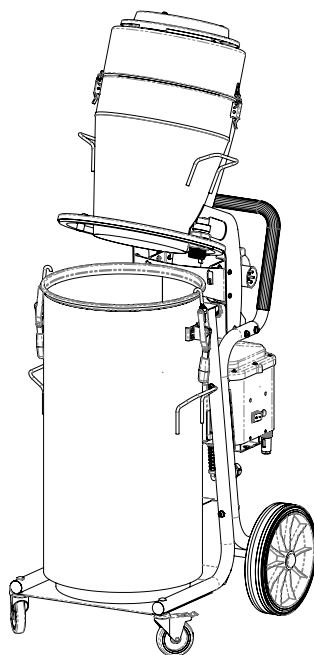

1. Afloje los clips que sujetan la tapa al barril.
2. Levante la parte trasera del ciclón usando las manijas en el costado del ciclón. Vea la imagen de arriba para conocer la posición del ciclón.
3. Si es necesario, el cañón se puede levantar del chasis.
4. Levante y ate la bolsa de plástico. Inserte una nueva bolsa de plástico.
5. Mueva el ciclón nuevamente al cañón y apriete las hebillas.

Puesta a punto/Mantenimiento

Limpeza

Durante la limpieza y el mantenimiento de la máquina, ésta debe estar apagada y desenchufada.

Cambio de los filtros

El filtro fino se debe cambiar por lo menos una vez al año. Solo se deben utilizar filtros originales. El filtro HEPA se debe cambiar al cabo de 300 horas.



AVISO

El cambio de los filtros solo lo debe realizar personal formado. Utilice una mascarilla protectora y el equipo adecuado.



ATENCIÓN

Cuando cambie el filtro, no debe utilizar ninguna herramienta/instrumento, ya que pueden dañar la superficie de estanqueidad del filtro.

1. Afloje y levante la parte superior para acceder libremente al filtro.

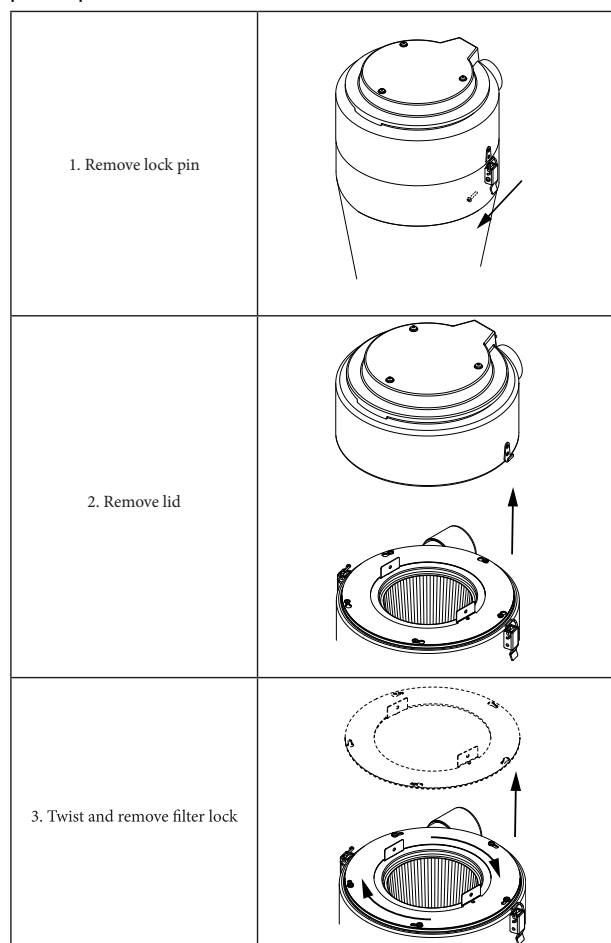

- 2.

3. Coloque la bolsa de plástico incluida sobre el ciclón para evitar que se esparza el polvo en el filtro.
4. Levante el filtro hacia arriba.
5. Selle la bolsa de plástico con el filtro usado.

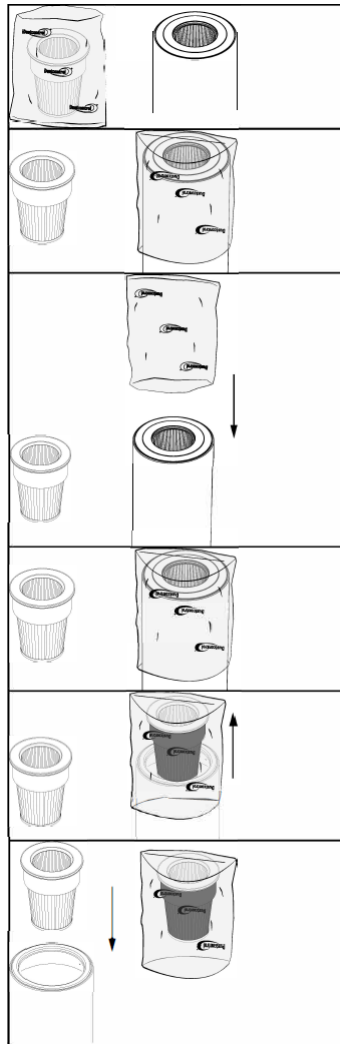

- 6.
7. Al cambiar el filtro, compruebe la junta.
8. Una junta con fugas puede causar la liberación de polvo peligroso para la salud.
9. Nunca use juntas viejas o filtros plagiados.
10. Los filtros reemplazados deben colocarse en una bolsa de plástico con cierre.

Motor

Para los motores del ventilador, la vida útil típica de los cepillos originales es de 600-700 horas. El cepillo se puede cambiar. Para el segundo paquete del cepillo, la vida útil es de aprox. 400 horas y para el tercer paquete del cepillo es de unas 300 horas. Después de este tiempo, el colector se desgasta hay que cambiar el motor.

Sobrecalentamiento

Si la máquina corre el riesgo de sobrecalentarse (por ejemplo, si va muy ahogada), el monitor de la temperatura se disolverá y la máquina se detendrá. En ese caso, es importante que el operario pulse el interruptor de alimentación y lo coloque en la posición «AV» (apagado), extraiga el alargador de la toma de corriente y espere 3-5 minutos hasta que la máquina se enfríe. A continuación, se vuelve a restablecer el monitor de la temperatura pulsando el botón RESET. Vuelva a montar el alargador en la toma de corriente y reinicie la máquina pulsando el interruptor de alimentación y colocándolo en la posición «PÁ» (encendido).

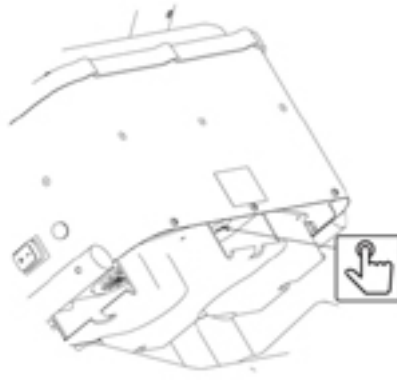

Control periódico

Verifique periódicamente que el cable de alimentación no esté dañado.

Accesorios y consumibles

Denominación	N.º de artículo
Manguito de conexión	2008
Manguito de conexión	2129
Manguera Ø=50	2013
filtro HEPA	44016
Poliéster de filtro fino	44017
Bolsa de plástico, 50 uds.	4314
MOTOR 1285W 230V 50/60Hz	42309-01

Para las piezas de repuesto, consulte el [sitio web de Dustcontrol](#).

Garantía

El período de garantía es de dos años y cubre los defectos de fabricación. La garantía se aplica siempre que la máquina se utilice de manera normal y reciba la puesta a punto requerida. No se sustituyen las piezas que han sufrido un desgaste normal. Las reparaciones las deberán realizar Dustcontrol o una persona autorizada por Dustcontrol. De lo contrario, la garantía quedará anulada.

Motor

El(los) motor(es) del producto no están cubiertos por la garantía. La vida útil de un motor puede ser de 600 a 700 horas de funcionamiento. Póngase en contacto con Dustcontrol si necesita cambiar el motor.

DetECCIÓN Y RESOLUCIÓN DE PROBLEMAS

Problema	Causa	Solución
El motor no funciona.	La electricidad no está conectada.	Conecte la electricidad.
El motor se detiene inmediatamente después de arrancar.	Fusible defectuoso.	Cambie y ponga un fusible correcto.
El motor funciona pero la máquina no succiona.	La manguera de succión no está conectada.	Conecte la manguera.
El motor funciona pero la máquina succiona mal.	La manguera de succión tiene agujeros.	Cambie la manguera.
	Filtro obstruido.	Límpielo o cámbielo.
	La manguera de succión es demasiado larga o demasiado estrecha.	Cambie la manguera.
	La manguera está parcialmente obstruida.	Gire la manguera o límpiela.
	La parte superior de la máquina está mal montada.	Ajuste el ensamblaje.
	Se ha acumulado polvo en el ciclón.	Quite la parte superior y limpie el ciclón.
El motor se detiene durante el funcionamiento.	El motor está sobrecalentado.	Verifique que la máquina no esté acelerada y espere hasta que la máquina se haya enfriado (aprox. 30 min).
La máquina expulsa polvo.	El filtro se ha aflojado o se ha roto.	Verifíquelo y sustitúyalo de ser preciso.
Ruido anormal procedente de la máquina.		Concierte una cita para que la pongan a punto.

Declaración de conformidad para el mercado CE

Por la presente certificamos que el DC Chip Extractor cumple con las siguientes regulaciones y estándares:

2006/42/EC, 2014/30/EU, 2014/35/EU, EN 60204-1:2018, EN1822-1:2019.

Dustcontrol AB



Nina Uggowitzner / CEO & Technical Manager

2024-09-30

Contacto

Dustcontrol Worldwide



AT
Dustcontrol Ges.m.b.H.
info@dustcontrol.at
www.dustcontrol.at



AU
All Preparation Equipment
www.allprep.com.au



BENELUX
Dust Solutions BV
www.dustsolutions.nl



BG
Metaltech14 Ltd.
metaltech14@abv.bg
www.dustcontrolbg.com



CA Dustcontrol
Canada Inc.
info@dustcontrol.ca
www.dustcontrol.ca



CH
Rosset Technik Maschinen
Werkzeuge AG
info@rosset-technik.ch
www.rosset-technik.ch



CL
Beckart Tecnologia Ambiental S.A.
ambitec@ambitec.cl
www.ambitec.cl



CN
Suzhou Dustcollect Filtration
Technology Co. Ltd.
wang@dustcollect.cn
www.dustcollect.cn



CZ / SK Ener
Group CZ, S.R.O. Infolinka:
+420 602 795 800
info@energrou.cz
www.prumysloveodsavani.cz/



DE
Dustcontrol GmbH
info@dustcontrol.de
www.dustcontrol.de



DK
Construction – Erenfred Pedersen A/S
info@ep.dk
www.ep.dk

Industry – Dansk Procesventilation ApS
info@dansk-procesventilation.dk
www.dansk-procesventilation.dk



EE
G-Color Baltic OÜ
sales@g-color.ee
www.g-color.ee



ES
Barin, s.a.
info@barin.es
www.barin.es



GB
Dustcontrol UK Ltd.
sales@dustcontrol.co.uk
www.dustcontrol.co.uk



GR
Mavrogiannakis S.A
ekttox@enternet.gr
www.ekttoxefits.com.gr



FI
Dustcontrol FIN OY
dc@dustcontrol.fi
www.dustcontrol.fi



FR
Construction – SMH Equipements
info@abequipements.com
www.smhequipements.com



Industry – Dustcontrol AB
info@dustcontrol.fra
www.dustcontrol.fra



HR
Kermek d.o.o.
kruno.nedeljko@kermek.com
www.kermek.com



HU
Vandras Kft
vandras@t-online.hu
www.vandras.hu



IN
Advance Ventilation Pve Ltd.
sales@advanceventilation.com
www.advanceventilation.com



IT
Airum srl
info@airum.com
www.airum.com



KR
ESH Engineering Co.
eshengco@gmail.com
www.eshengco.com



LT
UAB Hidromega
info@hidromega.lt
www.hidromega.lt



LV
SIA Reaktivs
reaktivs@reaktivs.lv
www.reaktivs.lv



MY, ID
Stada EnviroSpace Bhd
info@stada.com.my
www.stada.com.my



NO
Teijo Norge A.S
firmapost@teijo.no
www.teijo.no



NZ
Artizan Diamond Tools
enquiry@artizandiamond.co.nz
www.artizandiamond.co.nz



PE
Efixo
contacto@efixo.pe
www.efixo.pe



PH
Sweden Concrete Machines Inc.
peringe@packoskick.se
www.swedenconcretemachines.ph



PL
Bart Sp. z o.o.
info@bart-vent.pl
www.bart-vent.pl



PT
Metec-Mecano Técnica, Lda.
geral@metec.pt
www.metec.pt



RO
AWS Elektrotehnik
office@awstehnik.ro
www.awstehnik.ro

General Contractor Industry SRL
office@gci-grup.ro
www.gci-grup.ro



RS
Enel Alati
eneldoo@eunet.rs
www.eneldoo.rs



RU
Centre Vacuum System
panov.g@movers-td.com
www.dustcontrolrus.ru



SE
Dustcontrol AB
info@dustcontrol.se
www.dustcontrol.com



SG
Stada EnviroSpace Pte Ltd
Info@stada.com.my
www.stada.com.my



TW
Goodland Enterprise Co., Ltd.
sales@goodland.com.tw
www.goodland.com.tw



TH
MCON Intertrade Co., Ltd.
sales@mconintertrade.com
www.mconintertrade.com



TR Ventek
Mühendislik Ltd.
info@ventek.com.tr
www.ventek.com.tr



AE
Global Enterprises Trading Co L.L.C.
sales@globalentco.com
www.globalentco.com



GEM
Industrial Equipment Trading Co. Tel:
+971 4 8840 474
Email: gemuae@eim.ae



UA
MBK Obshemashkontrakt, JSC
zao@omk.dp.ua
www.omk.dp.ua



US
Dustcontrol Inc.
info@dustcontrolusa.com
www.dustcontrol.us



VN
Tayhostar JSC
tayhostar@tayhostar.vn
www.tayhostar.vn

Please contact the head office
in Sweden if you do not find a
distributor in your area.
info@dustcontrol.se

Mentions légales



AVIS

Traduction du manuel d'utilisation original



IMPORTANT

Lisez le manuel d'utilisation avant d'utiliser la machine.



IMPORTANT

Dustcontrol se réserve le droit de modifier les spécifications sans préavis et n'a aucune obligation de modifier les produits précédemment livrés. Dustcontrol n'est pas responsable des erreurs ou omissions dans ce manuel d'utilisation.



IMPORTANT

Toutes les réglementations de sécurité nationales, régionales et locales pertinentes doivent être respectées lors de l'installation et de l'utilisation de ce produit. Pour des raisons de sécurité et pour garantir le respect des données système documentées, seul le fabricant doit effectuer les réparations des composants. Le non-respect de ces informations peut entraîner des blessures corporelles ou des dommages matériels.



IMPORTANT

Tous droits réservés. Aucune partie de cette publication ne peut être reproduite, distribuée ou transmise sous quelque forme ou par quelque moyen que ce soit, y compris la photocopie, l'enregistrement ou tout autre moyen électronique ou mécanique, sans l'autorisation écrite préalable de l'éditeur. Pour les demandes de permis, contactez Dustcontrol.



AVIS

Le produit est fabriqué par :

Dustcontrol AB
Box 3088, Kumla Gårdsväg 14
SE-145 03 Norsborg
Tel: +46 8 531 940 00
support@dustcontrol.se
www.dustcontrol.com

Règles de sécurité

Introduction

Lisez les instructions de sécurité suivantes avant de démarrer cette machine. Enregistrez le manuel d'utilisation. Si les règles de sécurité ne sont pas respectées, la garantie ne s'applique pas. Des dommages personnels et matériels peuvent également survenir. Dustcontrol n'est pas responsable des dommages causés à l'équipement par une installation incorrecte ou une mauvaise manipulation de l'équipement.

Avertissement

Cette machine est destinée à un usage professionnel uniquement.

Les enfants doivent être surveillés pour s'assurer qu'ils ne jouent pas avec la machine.

N'utilisez que des accessoires et consommables d'origine inclus dans la gamme Dustcontrol.



AVERTISSEMENT

Utiliser la machine pour l'usage prévu. Suivre les instructions relatives au matériau aspiré.



AVERTISSEMENT

Cette machine est uniquement conçue pour l'aspiration de matière sèche.



AVERTISSEMENT

Lors de l'utilisation de dispositifs électriques, les consignes de sécurité de base doivent être suivies pour réduire le risque d'incendie, de choc électrique ou de blessure.



AVERTISSEMENT

Aucune particule chaude, incandescente ou autre source d'inflammation ne doit être aspirée par la machine. La machine ne doit pas être utilisée pour des particules explosives, instables ou auto-inflammables.



AVERTISSEMENT

Lors de l'utilisation d'articles défectueux ou non d'origine (en particulier les filtres, les tuyaux et les sacs en plastique), des fuites de poussières nocives avec risque de blessures sont possibles.

Protection de l'environnement

Recyclez l'emballage et les composants inclus conformément aux réglementations locales. Pour plus d'informations, contactez votre déchetterie la plus proche ou Dustcontrol pour la mise au rebut des machines.

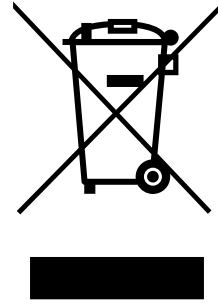
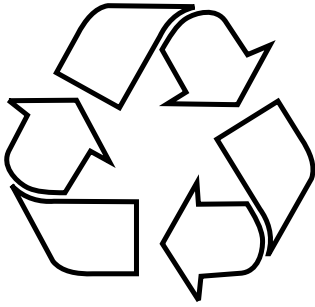

DEEE (Déchets d'équipements électriques et électroniques)

S'applique uniquement aux pays de l'UE : Les outils électriques ne doivent pas être jetés dans les ordures ménagères. En vertu de la directive 2002/96/CE relative aux équipements électriques et électroniques plus anciens et de son application en droit national, les outils électriques en fin de vie doivent être triés et soumis à un recyclage respectueux de l'environnement.

Environnement de travail

Ne pas exposer la machine à l'humidité. Ne pas utiliser la machine dans des espaces humides et mouillés ou à proximité de liquides ou de gaz inflammables.



ATTENTION

Utiliser et entreposer la machine uniquement dans un environnement sec.



ATTENTION

Ne pas rincer la machine avec de l'eau.

Surcharge



ATTENTION

Ne jamais laisser la machine tourner à une puissance de moteur réduite en raison du risque de surchauffe.

Blessures corporelles



AVERTISSEMENT

Ne jamais prendre l'initiative de modifier les branchements électriques. Une erreur pourrait être fatale !



AVERTISSEMENT

Ne jamais laisser le point d'aspiration entrer en contact avec une partie quelconque du corps. La forte dépression peut endommager les vaisseaux sanguins de la peau.



AVERTISSEMENT

Des gants de protection doivent être portés lors du montage, de la manipulation et du transport du produit.

Câble électrique



AVERTISSEMENT

Ne jamais tirer la machine par le cordon d'alimentation. Ne pas exposer le cordon d'alimentation à la chaleur ou aux objets tranchants. Vérifier régulièrement le cordon d'alimentation.

Lors de l'épissage du cordon d'alimentation, l'extension doit être étanche.

La machine ne doit pas être utilisée si les cordons d'alimentation ou les contacts sont endommagés.

Si le cordon d'alimentation est endommagé, il doit être remplacé par Dustcontrol ou par un centre de service autorisé Dustcontrol.

Action importante

Éteindre la machine avec l'interrupteur principal et la débrancher de l'alimentation secteur avant tout nettoyage ou entretien.

Cette machine ne peut être utilisée que si tous les filtres sont en bon état et correctement installés.

Soins

La machine doit toujours être propre et sans dépôts de poussière. Vérifier que le tuyau d'aspiration est en bon état et que tous les joints sont intacts et impeccables. Les poignées de transport doivent toujours être sèches et exemptes d'huile et de graisse.

Contrôle

Contrôler régulièrement que l'unité n'est pas endommagée ni usée. En cas de dommages, ceux-ci doivent être réparés par le technicien de maintenance de Dustcontrol ou par un atelier de maintenance agréé par Dustcontrol.

Description fonctionnelle

Le dépoussiéreur fonctionne avec une pression négative (aspiration) qui entraîne l'air à travers la hotte d'aspiration / la buse, le système de tuyaux et le pré- et séparateur de poussière. La séparation grossière a lieu dans le cyclone de l'unité, qui est une séparation très efficace des poussières de plus en plus grossières. La poussière fine est séparée dans le filtre de l'appareil. Le nettoyage du filtre avec impulsion d'air donne aux filtres une durée de vie extra longue. La machine est équipée de filtres HEPA.

DC Tromb 400 est utilisé pour l'extraction ponctuelle (avec une réduction maximale de Ø 15 mm) dans de nombreux contextes, par exemple lors de meulage, soudage, assainissement personnel et nettoyage. Le DC Tromb 400 est alimenté par deux ventilateurs monophasés à 2 vitesses.

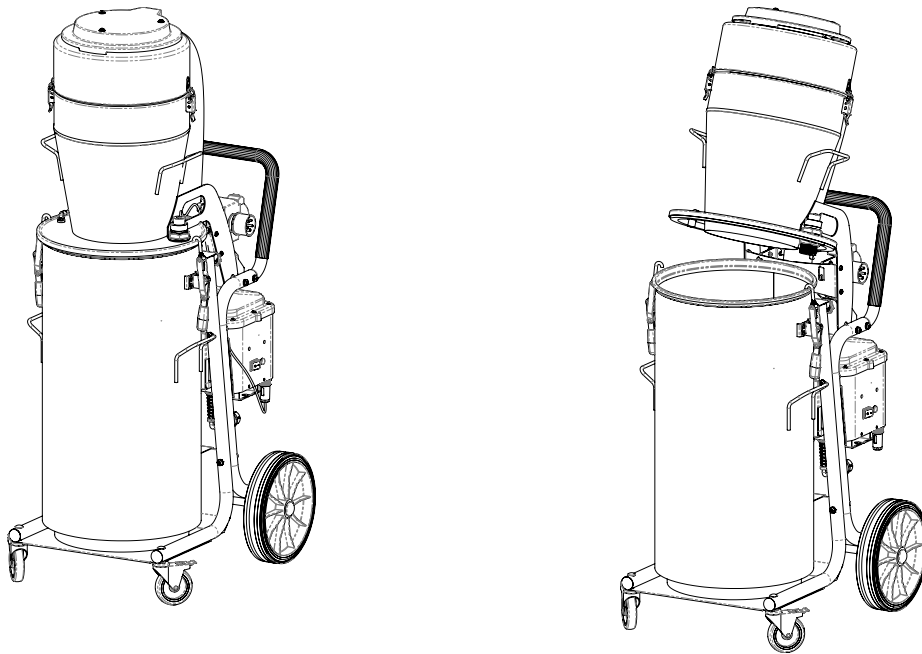

Le dépoussiéreur a l'option de décharge suivante:

a- Conteneur : Un conteneur cylindrique pour la collecte des matériaux séparés.

Caractéristiques techniques

Caractéristiques techniques	DC Chip Extractor
HxIxP [mm]	1530 x 600 x 780
Poids [kg]	70
Ø entrée [mm]	76
Longueur du tuyau Ø50mm [m]	7.5
Récipient de collecte [l]	90
Débit max. ventilateur (UE) 230V [w ³ /h]	355
Sous-pression max. [kPa]	22
Prise de courant (UE) 230 V [W]	2600
Filtre fin polyester, surface [m ²]	1.85
Degré de séparation filtre fin, EN 60335-2-69, classe M [%]	99.9
Surface filtrante microfiltre [m ²]	2.2
Classification des filtres, EN 1822-1	HEPA H13
Degré de séparation machine, EN 60335-2-69, Annexe A-A, Classe H [%]	99.995
Niveau sonore [dB(A)]	70
N° d'art.	174100

Opération

Branchement

Brancher la machine à une prise électrique conforme aux indications de la plaque signalétique de la machine.

Démarrateur automatique (ALV10)

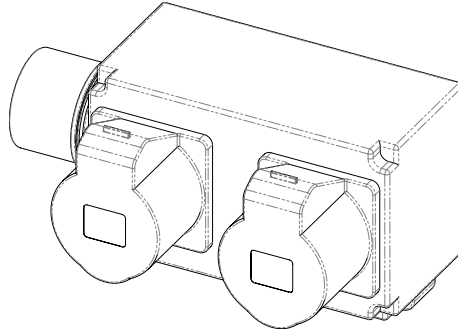

Selon les règles de sécurité en vigueur lors du travail avec des machines à bois, les poussières dangereuses doivent être aspirées efficacement par un aspirateur à copeaux.

Ce démarreur temporisé démarre automatiquement l'extracteur de copeaux après 2-3 secondes et protège ainsi contre une surcharge du fusible.

Après l'arrêt de la machine, l'aspiration des copeaux continue pendant 3 à 4 secondes supplémentaires et aspire ainsi la poussière restante des tuyaux.

Nettoyage du filtre

La machine est équipée d'un voyant de filtre qui s'allume lorsque le filtre doit être nettoyé ou remplacé.

Instructions pour le nettoyage du filtre

1. Laissez la machine allumée, réinitialisez le bouton de nettoyage du filtre et fermez le registre de l'entrée du cyclone.
2. Attendez 5 à 10 impulsions.
3. Éteignez la machine.
4. Réinitialisez le bouton de nettoyage du filtre et ouvrez le registre sur l'entrée du cyclone.
5. Démarrez la machine. Vérifiez que le voyant du filtre est éteint. Sinon, répétez la procédure. Si le voyant s'allume même après la répétition, le filtre fin doit être remplacé.



Vidange



AVIS

Des capteurs de niveau avertissent lorsque le baril est plein et doit être vidé.

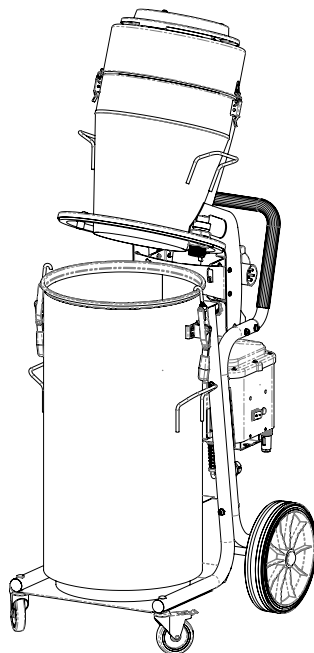

1. Desserrez les clips qui fixent le couvercle au canon.
2. Soulevez l'arrière du cyclone à l'aide des poignées situées sur le côté du cyclone. Voir l'image ci-dessus pour la position du cyclone.
3. Si nécessaire, le canon peut être soulevé du châssis.
4. Soulevez et attachez le sac en plastique. Insérez un nouveau sac en plastique.
5. Remettez le cyclone sur le canon et serrez les boucles.

Entretien/maintenance

Nettoyage

Lors du nettoyage et de l'entretien de la machine, la machine doit être éteinte et la fiche débranchée.

Remplacement de filtre

Le filtre fin doit être changé au moins une fois par an. Seuls des filtres d'origine peuvent être utilisés. Les filtres HEPA doivent être remplacés après 300 heures.



AVERTISSEMENT

Le remplacement du filtre ne peut être effectué que par un personnel formé. Utiliser un masque de protection et un équipement approprié.



ATTENTION

Lors du changement de filtre, aucun outil/instrument contondant ne doit être utilisé, car il pourrait endommager la surface d'étanchéité du filtre.

1. Desserrez et soulevez la partie supérieure pour accéder librement au filtre.

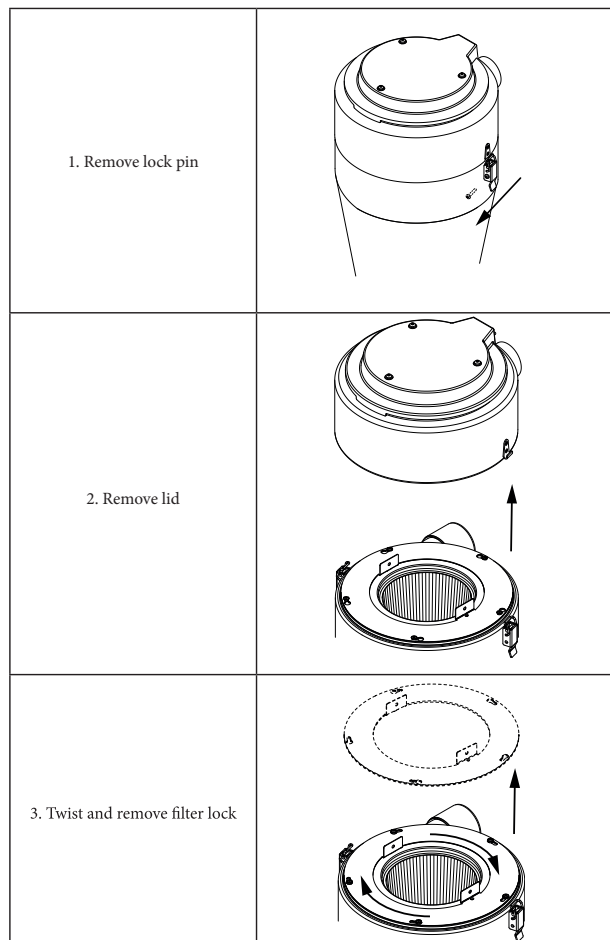

- 2.

3. Placez le sac en plastique fourni sur le cyclone pour empêcher la poussière présente dans le filtre de se propager.
4. Soulevez le filtre vers le haut.
5. Scellez le sac en plastique avec le filtre usagé.

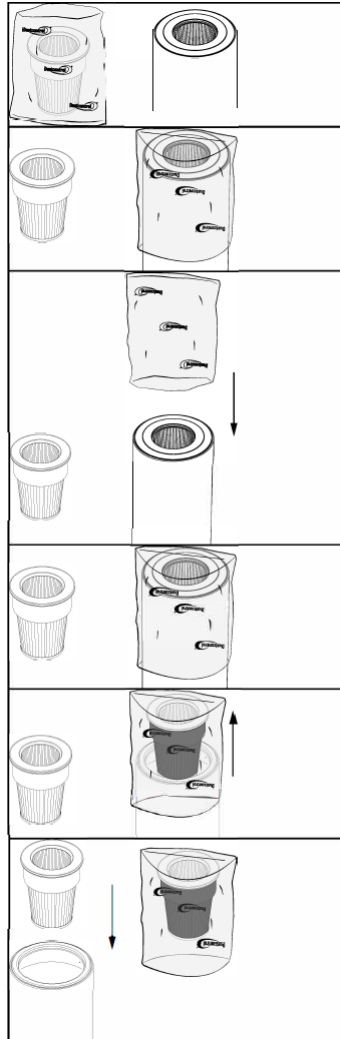

- 6.
7. Lors du changement du filtre, vérifiez le joint.
8. Un joint qui fuit peut provoquer le dégagement de poussières dangereuses pour la santé.
9. N'utilisez jamais de vieux joints ou de filtres plagiés.
10. Les filtres remplacés doivent être placés dans un sac en plastique refermable.

Moteur

Pour les moteurs à ventilateur, la durée de vie typique des balais d'origine est 600-700 heures. La brosse peut être remplacée. Le deuxième jeu de brosses a une durée de vie d'environ 400 heures et le troisième d'environ 300 heures. Le collecteur est alors usé et le moteur doit être remplacé.

Surchauffe

Si la machine risque la surchauffe (exemple : en cas de réduction importante), le contrôleur de température se déclenche et la machine s'arrête. Il est alors important que l'opérateur appuie sur l'interrupteur d'alimentation pour éteindre la machine, débranche le cordon de la prise électrique et patiente 3-5 minutes pour que la machine refroidisse. Le contrôleur de température est ensuite réinitialisé en appuyant sur le bouton RESET. Rebrancher le cordon dans la prise électrique et redémarrer la machine en appuyant sur l'interrupteur.

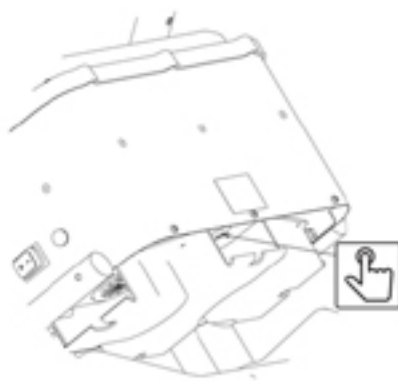

Contrôle régulier

Contrôler régulièrement que le cordon d'alimentation n'est pas endommagé.

Accessoires et consommables

Désignation	Réf.
Manchon de raccordement	2008
Manchon de raccordement	2129
Tuyau Ø = 50	2013
Filtre HEPA	44016
Filtre fin en polyester	44017
Sac en plastique, 50 unités	4314
MOTOR 1285W 230V 50/60Hz	42309-01

Pour les pièces détachées, consulter [la page d'accueil de Dustcontrol](#).

Garantie

La période de garantie est de deux ans et concerne les défauts de fabrication. La garantie s'applique à condition que la machine soit utilisée dans des conditions normales et que l'entretien nécessaire est réalisé. L'usure normale n'est pas couverte par la garantie. Les réparations sont effectuées par Dustcontrol ou par une personne agréée par Dustcontrol. Sinon, la garantie est annulée.

Moteur

Le ou les moteurs du produit ne sont pas couverts par la garantie. La durée de vie d'un moteur peut être comprise entre 600 et 700 heures de fonctionnement. Contactez Dustcontrol si vous devez changer le moteur.

Recherche de pannes

Problème	Cause	Action
Le moteur ne fonctionne pas.	La machine n'est pas branchée à la prise secteur.	Brancher la machine.
Le moteur s'arrête immédiatement après le démarrage.	Mauvais fusible.	Remplacer par un fusible correct.
Le moteur fonctionne, mais la machine n'aspire pas.	Le tuyau d'aspiration n'est pas raccordé.	Brancher le tuyau.
Le moteur fonctionne, mais la machine n'aspire pas bien.	Tuyau d'aspiration troué.	Changer le tuyau.
	Filtre bouché.	Nettoyer ou remplacer.
	Tuyau d'aspiration trop long ou étroit.	Changer le tuyau.
	Tuyau partiellement bouché.	Retourner le tuyau ou le nettoyer.
	Partie supérieure de la machine mal montée.	Vérifier le montage.
	La poussière est piégée dans le cyclone.	Enlever la partie supérieure et nettoyer le cyclone.
Le moteur s'arrête pendant le fonctionnement.	Le moteur est en surchauffe.	Vérifiez que la machine n'est pas étranglée et attendez que la machine ait refroidi (environ 30 min).
La machine libère de la poussière.	Le filtre est desserré ou cassé.	Vérifier et remplacer si nécessaire.
Bruit anormal de la machine.		Demander l'intervention d'un technicien.

Déclaration CE

Nous certifions par la présente que le DC Chip Extractor est conforme aux réglementations et normes suivantes :

2006/42/EC, 2014/30/EU, 2014/35/EU, EN 60204-1:2018, EN1822-1:2019.

Dustcontrol AB



Nina Uggowitzner / CEO & Technical Manager

2024-09-30

Contact

Dustcontrol Worldwide



AT
Dustcontrol Ges.m.b.H.
info@dustcontrol.at
www.dustcontrol.at



AU
All Preparation Equipment
www.allprep.com.au



BENELUX
Dust Solutions BV
www.dustsolutions.nl



BG
Metaltech14 Ltd.
metaltech14@abv.bg
www.dustcontrolbg.com



CA Dustcontrol
Canada Inc.
info@dustcontrol.ca
www.dustcontrol.ca



CH
Rosset Technik Maschinen
Werkzeuge AG
info@rosset-technik.ch
www.rosset-technik.ch



CL
Beckart Tecnologia Ambiental S.A.
ambitec@ambitec.cl
www.ambitec.cl



CN
Suzhou Dustcollect Filtration
Technology Co. Ltd.
wang@dustcollect.cn
www.dustcollect.cn



CZ / SK Ener
Group CZ, S.R.O. Infolinka:
+420 602 795 800
info@energrou.cz
www.prumysloveodsavani.cz/



DE
Dustcontrol GmbH
info@dustcontrol.de
www.dustcontrol.de



DK
Construction – Erenfred Pedersen A/S
info@ep.dk
www.ep.dk

Industry – Dansk Procesventilation ApS
info@dansk-procesventilation.dk
www.dansk-procesventilation.dk



EE
G-Color Baltic OÜ
sales@g-color.ee
www.g-color.ee



ES
Barin, s.a.
info@barin.es
www.barin.es



GB
Dustcontrol UK Ltd.
sales@dustcontrol.co.uk
www.dustcontrol.co.uk



GR
Mavrogiannakis S.A
ekttox@enternet.gr
www.ekttoxefits.com.gr



FI
Dustcontrol FIN OY
dc@dustcontrol.fi
www.dustcontrol.fi



FR
Construction – SMH Equipements
info@abequipements.com
www.smhequipements.com



Industry – Dustcontrol AB
info@dustcontrol.fra
www.dustcontrol.fra



HR
Kermek d.o.o.
kruno.nedeljko@kermek.com
www.kermek.com



HU
Vandras Kft
vandras@t-online.hu
www.vandras.hu



IN
Advance Ventilation Pve Ltd.
sales@advanceventilation.com
www.advanceventilation.com



IT
Airum srl
info@airum.com
www.airum.com



KR
ESH Engineering Co.
eshengco@gmail.com
www.eshengco.com



LT
UAB Hidromega
info@hidromega.lt
www.hidromega.lt



LV
SIA Reaktivs
reaktivs@reaktivs.lv
www.reaktivs.lv



MY, ID
Stada EnviroSpace Bhd
info@stada.com.my
www.stada.com.my



NO
Teijo Norge A.S
firmapost@teijo.no
www.teijo.no



NZ
Artizan Diamond Tools
enquiry@artizandiamond.co.nz
www.artizandiamond.co.nz



PE
Efixo
contacto@efixo.pe
www.efixo.pe



PH
Sweden Concrete Machines Inc.
peringe@packoskick.se
www.swedenconcretemachines.ph



PL
Bart Sp. z o.o.
info@bart-vent.pl
www.bart-vent.pl



PT
Metec-Mecano Técnica, Lda.
geral@metec.pt
www.metec.pt



RO
AWS Elektrotehnik
office@awstehnik.ro
www.awstehnik.ro

General Contractor Industry SRL
office@gci-grup.ro
www.gci-grup.ro



RS
Enel Alati
eneldoo@eunet.rs
www.eneldoo.rs



RU
Centre Vacuum System
panov.g@movers-td.com
www.dustcontrolrus.ru



SE
Dustcontrol AB
info@dustcontrol.se
www.dustcontrol.com



SG
Stada EnviroSpace Pte Ltd
Info@stada.com.my
www.stada.com.my



TW
Goodland Enterprise Co., Ltd.
sales@goodland.com.tw
www.goodland.com.tw



TH
MCON Intertrade Co., Ltd.
sales@mconintertrade.com
www.mconintertrade.com



TR Ventek
Mühendislik Ltd.
info@ventek.com.tr
www.ventek.com.tr



AE
Global Enterprises Trading Co L.L.C.
sales@globalentco.com
www.globalentco.com



GEM
Industrial Equipment Trading Co. Tel:
+971 4 8840 474
Email: gemuae@eim.ae



UA
MBK Obshemashkontrakt, JSC
zao@omk.dp.ua
www.omk.dp.ua



US
Dustcontrol Inc.
info@dustcontrolusa.com
www.dustcontrol.us



VN
Tayhostar JSC
tayhostar@tayhostar.vn
www.tayhostar.vn

Please contact the head office
in Sweden if you do not find a
distributor in your area.
info@dustcontrol.se

Oikeudellinen huomautus



HUOMAUTUS

Alkuperäisen käyttöoppaan käännös



TÄRKEÄÄ

Lue käyttöohje ennen koneen käyttöä.



TÄRKEÄÄ

Dustcontrol pidättää oikeuden muuttaa teknisiä tietoja ilman erillistä ilmoitusta, eikä sillä ole velvollisuutta muuttaa aiemmin toimitettuja tuotteita. Dustcontrol ei ole vastuussa tämän käyttöoppaan virheistä tai puutteista.



TÄRKEÄÄ

Kaikkia asiaankuuluvia valtion, alueellisia ja paikallisia turvallisuusmääräyksiä on noudatettava tämän tuotteen asennuksessa ja käytössä. Turvallisuussyistä ja dokumentoitujen järjestelmätietojen noudattamisen varmistamiseksi vain valmistaja saa suorittaa komponenttien korjauksia. Jos näitä tietoja ei noudateta, seurauksena voi olla henkilövahinko tai laitevaurio.



TÄRKEÄÄ

Kaikki oikeudet pidätetään. Mitään tämän julkaisun osaa ei saa jäljentää, levittää tai välittää missään muodossa tai millään tavalla, mukaan lukien valokopiointi, tallennus tai muut elektroniset tai mekaaniset keinot, ilman julkaisijan etukäteen antamaa kirjallista lupaa. Lupakysymyksiä varten ota yhteyttä Dustcontroliin.



HUOMAUTUS

Tuotteen valmistaja:

Dustcontrol AB
 Box 3088, Kumla Gårdsväg 14
 SE-145 03 Norsborg
 Tel: +46 8 531 940 00
 support@dustcontrol.se
 www.dustcontrol.com

Turvallisuusmääräykset

Johdanto

Lue seuraavat turvallisuusohjeet ennen tämän koneen käynnistämistä. Säilytä käyttöohje. Jos turvallisuusmääräyksiä ei noudateta, takuu ei ole voimassa. Myös henkilö- ja tuotevaurioita voi tapahtua. Dustcontrol ei ole vastuussa virheellisestä asennuksesta tai laitteen väärästä käsittelystä aiheutuneista laitteille aiheutuneista vaurioista.

Varoitus

Tämä kone on tarkoitettu vain ammattikäyttöön.

Lapsia on valvottava sen varmistamiseksi, etteivät he leiki koneella.

Käytä vain alkuperäisiä lisävarusteita ja kulutustarvikkeita, jotka sisältyvät Dustcontrolin valikoimaan.



VAROITUS

Käytä konetta vain sen käyttötarkoitukseen. Noudata imettävänä olevaa materiaalia koskevia ohjeita.



VAROITUS

Tämä kone on tarkoitettu vain kuivan materiaalin imemiseen.



VAROITUS

Sähkölaitteiden käytössä on noudatettava tärkeitä turvallisuusohjeita tulipalon, sähköiskun tai henkilövahinkojen välttämiseksi.



VAROITUS

Koneeseen ei saa imeä kuumia tai hehkuvia hiukkasia eikä muita syttymislähteitä. Konetta ei saa käyttää räjähtäville, epästabiileille eikä itsestään syttyville hiukkasille.



VAROITUS

Käytettäessä väärä tuotteita tai kopioita (varsinkin suodattimia, letkuja ja muovisäkkejä) voi kone vuotaa hengenvaarallista pölyä, joka vahingoittaa terveyttä.

Ympäristönsuojelu

Kierrätä pakkaus ja mukana tulevat komponentit paikallisten määräysten mukaisesti. Lisätietoja saat lähimmältä kierrätyskeskukselta tai Dustcontrolilta koneen romuttamista varten.

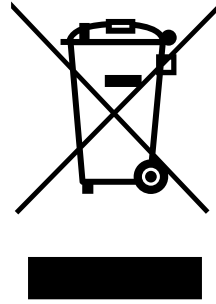
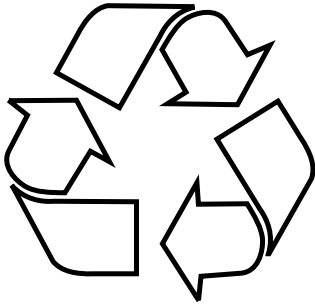

WEEE (Waste of Electric and Electronic Equipment)

Koskee vain EU-maita: Sähkölaitteita ei saa hävittää kotitalousjätteen mukana. Sähkö- ja elektroniikkalaiteromusta annetun direktiivin 2002/96/EY ja sen kansallisessa lainsäädännössä soveltamista koskevien määräysten mukaisesti on käytetyt sähkötyökalut lajiteltava erikseen ja toimitettava kierrätettäviksi ympäristöystävällisellä tavalla.

Työympäristö

Älä altista konetta kastumiselle. Älä käytä sitä kosteissa tai märissä tiloissa eikä helposti syttyvien nesteiden tai kaasujen lähellä.



VARO

Tätä konetta saa käyttää ja säilyttää vain kuivissa ympäristöissä.



VARO

Konetta ei saa huuhdella vedellä.

Ylikuormitus



VARO

Älä anna koneen koskaan toimia täysin kuristettuna, sillä se aiheuttaa ylikuormitusvaaran.

Ruumiinvammat



VAROITUS

Älä koskaan yritä itse muuttaa sähköliitäntöjä. Virhe voi olla hengenvaarallinen!



VAROITUS

Älä koskaan anna imukohdan koskettaa mitään kehonosaa. Voimakas alipaine voi vahingoittaa ihon verisuonistoa.



VAROITUS

Tuotetta asennettaessa, käsiteltäessä ja kuljettaessa on käytettävä suojakäsineitä.

Sähkökaapeli



VAROITUS

Älä koskaan vedä konetta virtajohdosta. Älä altista virtajohtoa lämmölle tai teräville esineille. Tarkasta virtajohto säännöllisin väliajoin.

Jatkettaessa virtajohtoa on jatkojohdon oltava kosteussuojattu.

Koetta ei saa käyttää, jos sähkökaapelit tai liittimet ovat vahingoittuneet.

Jos virtajohto on vahingoittunut, Dustcontrolin tai Dustcontrolin valtuuttaman huoltoliikkeen on annettava vaihtaa se.

Tärkeä toimenpide

Katkaise virta pääkatkaisimesta ja irrota kone sähköverkosta ennen koneen puhdistamista tai huoltamista.

Tätä konetta saa käyttää vain, jos kaikki suodattimet ovat ehjät ja oikein asennettu.

Hoito

Pidä kone puhtaana ja vapaana pölykerrostumista. Varmista, että imuletku on ehjä ja kaikki tiivisteet ovat vahingoittumattomia ja kunnossa. Pidä kahvat kuivina sekä öljyttöminä ja rasvattomina.

Ohjaus

Tarkasta säännöllisesti, että laitteessa ei ole vaurioita eikä kulumia. Jos vaurioita syntyy, ne on korjautettava Dustcontrolin huoltoteknikolla tai Dustcontrolin hyväksymässä huoltoliikkeessä.

Toimintojen kuvaus

Pölynkerääjä toimii alipaineella (imu), joka ohjaa ilman imukuvun/suuttimen, letkujärjestelmän sekä esi- ja pölynerottimen läpi. Karkeaerottelu tapahtuu yksikön syklonissa, mikä on erittäin tehokas yhä karkeamman pölyn erottelu. Hieno pöly erotetaan laitteen suodattimesta. Suodattimen puhdistus ilmapulssilla antaa suodattimille erityisen pitkän käyttöiän. Kone on varustettu HEPA-suodattimilla.

DC Tromb 400 soveltuu kohdepoistoon (maksimikuristus Ø 15 mm) useissa eri kohteissa, esim. hionta, hitsaus, saneeraus ja siivous. DC Tromb 400 toimii kahdella yksivaiheisella, 2-nopeuksisella puhaltimella.

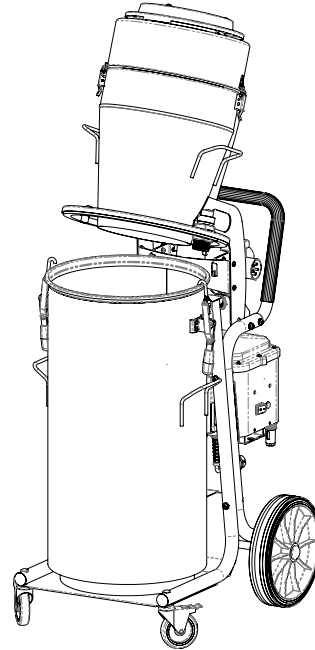
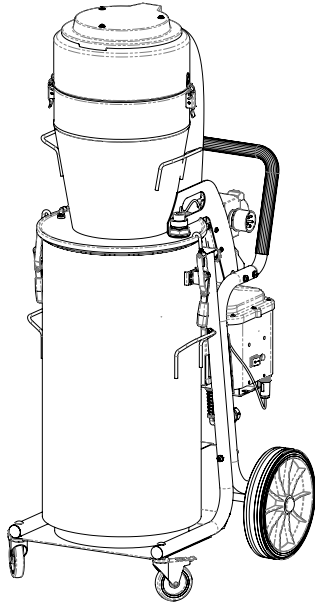

Pölynkerääjässä on seuraava tyhjennysvaihtoehto:

a- Säiliö: Lieriömäinen säiliö erotetun materiaalin keräämiseen.

Tekniset tiedot

Tekniset tiedot	DC Chip Extractor
KxLxS [mm]	1530 x 600 x 780
Paino [kg]	70
Tuloaukon Ø [mm]	76
Letkun pituus Ø50mm [m]	7.5
Keruuastia [l]	90
Virtaus max. tuuletin (EU) 230V [w ³ /h]	355
Alipaine maks. [kPa]	22
Pistorasia (EU) 230 V [W]	2600
Hienosuodatin polyesteri, pinta-ala [m ²]	1.85
Hienosuodattimen suodatusaste, EN 60335-2-69, luokka M [%]	99.9
Mikrosuodattimen suodatuspinta-ala [m ²]	2.2
Suodatinluokka, EN 1822-1	HEPA H13
Koneen suodatusaste, EN 60335-2-69, liite A-A, luokka H [%]	99.995
Äänitaso [dB(A)]	70
Tuotenro	174100

Toiminta

Kytkeminen

Kytke kone pistorasiaan, jonka jännite vastaa koneen tyyppikilvessä annettuja tietoja.

Automaattikäynnistin (ALV10)

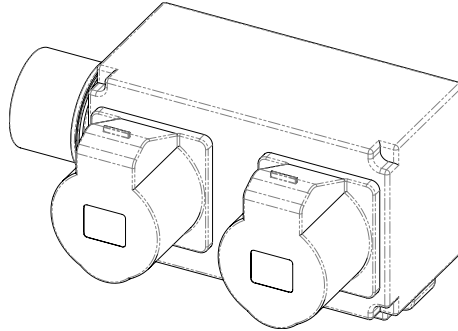

Nykyisten turvallisuusmääräysten mukaan puuntyöstökoneilla työskenneltäessä vaarallinen pöly on imettävä tehokkaasti lastunpoistimella.

Tämä viiveellä varustettu käynnistin käynnistää lastunpoistimen automaattisesti 2-3 sekunnin kuluttua ja suojaa siten sulakkeen ylikuormitukselta.

Kun kone on pysäytetty, lastuimuri jatkuu vielä 3-4 sekuntia ja imee siten jäljellä olevan pölyn letkuista.

Suodattimen puhdistus

Koneessa on suodattimen merkkivalo, joka syttyy, kun suodatin on puhdistettava tai vaihdettava.

Ohjeet suodattimen puhdistamiseen

1. Jätä kone päälle, nollaa suodattimen puhdistuspainike ja sulje syklonin tuloaukon pelti.
2. Odota 5-10 pulssia.
3. Sammuta kone.
4. Nollaa suodattimen puhdistuspainike ja avaa syklonin sisääntulon pelti.
5. Käynnistä kone. Tarkista, että suodattimen merkkivalo ei pala. Jos ei - toista toimenpide. Jos lamppu syttyy toiston jälkeenkin, hienosuodatin on vaihdettava.



Valua



HUOMAUTUS

Tasointurit varoittavat, kun tynnyri on täynnä ja se on tyhjennettävä.

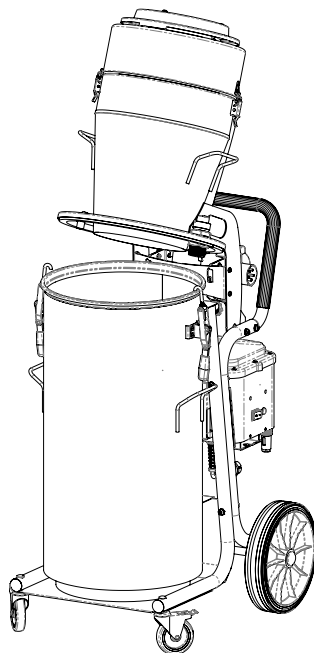

1. Löysää pidikkeet, jotka kiinnittävät kannen piippuun.
2. Nosta syklonin takaosaa syklonin kyljessä olevista kahvoista. Katso yllä olevasta kuvasta syklonin sijainti.
3. Tarvittaessa piippu voidaan nostaa rungosta.
4. Nosta ja sido muovipussi. Aseta uusi muovipussi paikoilleen.
5. Siirrä sykloni takaisin piippuun ja kiristä soljet.

Huolto/Ylläpito

Puhdistus

Koneen puhdistuksen ja huollon aikana kone on sammutettava ja pistoke irrotettava.

Suodattimen vaihto

Hienosuodatin on vaihdettava vähintään kerran vuodessa. Vain alkuperäissuodattimen käyttö on sallittu. HEPA-suodatin on vaihdettava 300 tunnin jälkeen.



VAROITUS

Suodattimen saa vaihtaa vain koulutettu työntekijä. Käytä hengityssuojainta ja asianmukaisia varusteita.



VARO

Suodatinta vaihdettaessa ei saa käyttää työkaluja/apuvälineitä, sillä ne voivat vahingoittaa suodattimen tiivistepintaa.

1. Löysää ja nosta yläosa irti päästäksesi vapaasti käsiksi suodattimeen.

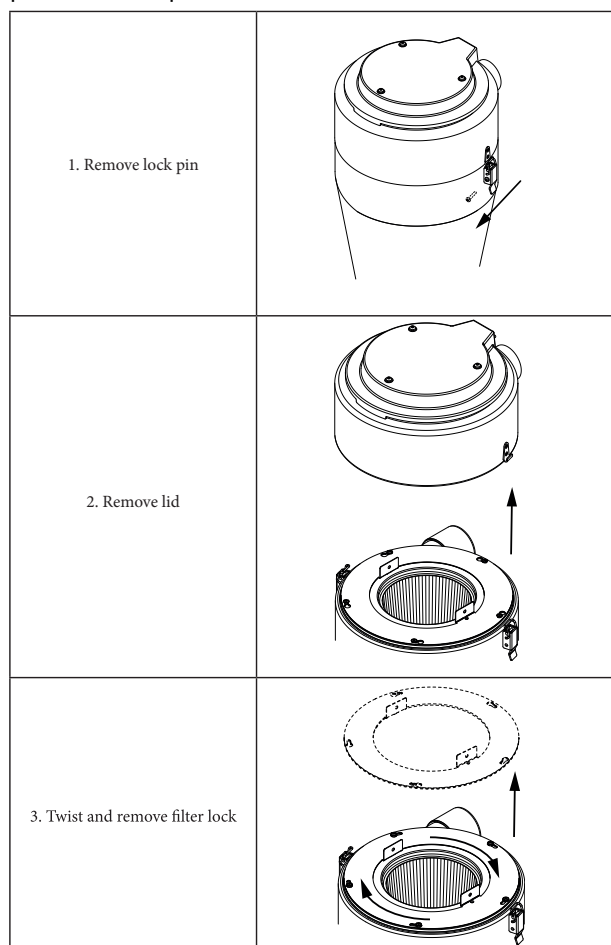

- 2.

3. Laita mukana toimitettu muovipussi syklonin päälle, jotta suodattimessa oleva pöly ei pääse leviämään.
4. Nosta suodatin suoraan ylös.
5. Sulje muovipussi käytetyllä suodattimella.

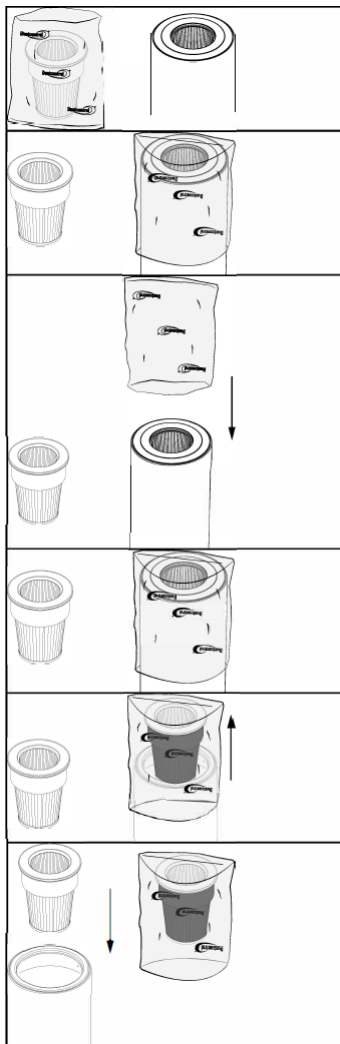

- 6.
7. Kun vaihdat suodatinta, tarkista tiiviste.
8. Vuotava tiiviste voi aiheuttaa terveydelle haitallisen pölyn vapautumisen.
9. Älä koskaan käytä vanhoja tiivisteitä tai plagioituja suodattimia.
10. Vaihdetut suodattimet on laitettava uudelleen suljettavaan muovipussiin.

Moottori

Puhallinmoottoreiden tyypillinen käyttöaika on 600-700 tuntia. Harja on mahdollista vaihtaa. Toisen harjapaketin käyttöaika on noin 400 tuntia, ja kolmannen harjapaketin noin 300 tuntia. Tämän jälkeen kollektori on kulunut loppuun ja moottori on vaihdettava.

Ylikuumentuminen

Jos kone on vaarassa ylikuumentua (esimerkiksi voimakkaan kuristuksen vuoksi), lämpökytkin laukeaa ja kone pysähtyy. Silloin koneenkäyttäjän on tärkeää painaa virtakytkin OFF-asentoon, irrottaa johto pistorasiasta ja odottaa 3-5 minuuttia koneen jäähtymistä. Tämän jälkeen lämpökytkin palautetaan normaalitilaan RESET-painikkeella. Kytke johto takaisin pistorasiaan ja käynnistä kone painamalla virtakytkin ON-asentoon.

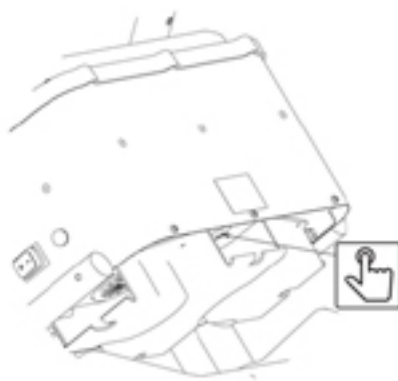

Säännöllinen tarkastus

Tarkasta virtajohto säännöllisesti vaurioitten varalta.

Tarvikkeet ja kulutustarvikkeet

Nimitys	Tuotenro
Liitäntämuhvi	2008
Liitäntämuhvi	2129
Letku Ø=50	2013
HEPA-suodatin	44016
Hieno suodatinpolyesteri	44017
Muovisäkki, 50 kpl	4314
MOTOR 1285W 230V 50/60Hz	42309-01

Katso varaosat [Dustcontrolin kotisivulta](#).

Takuu

Takuuaika on kaksi vuotta ja koskee valmistusvirheitä. Takuun voimassaolo edellyttää, että konetta käytetään normaalilla tavalla ja sitä huolletaan vaatimusten mukaisesti. Normaalista kulumista ei korvata. Korjaukset on teetettävä Dustcontrolilla tai Dustcontrolin hyväksymällä henkilöllä. Muussa tapauksessa takuu raukeaa.

Moottori

Tuotteen moottori(t) eivät kuulu takuun piiriin. Moottorin näytteen käyttöikä voi olla 600 - 700 käyttötuntia. Ota yhteyttä Dustcontroliin, jos sinun on vaihdettava moottori.

Vianmääritys

Ongelma	Syy	Toimenpide
Moottori ei käy.	Sähkö ei ole kytkettynä.	Kytke sähkö.
Moottori pysähtyy heti käynnistyksen jälkeen.	Vääränlainen sulake.	Vaihda oikea sulake.
Moottori käy mutta kone ei ime.	Imuletku ei ole kytkettynä.	Kytke letku.
Moottori käy mutta kone imee huonosti.	Imuletkussa on reikä.	Vaihda letku.
	Suodatin on tukkeutunut.	Puhdista tai vaihda.
	Imuletku on liian pitkä tai kapea.	Vaihda letku.
	Letku on osittain tukossa.	Käännä letkua tai puhdista se.
	Koneen yläosa on huonosti kiinnitetty.	Korjaa kiinnitystä.
	Sykloniin on takertunut pölyä.	Irrota yläosa ja puhdista sykloni.
Moottori pysähtyy käytön aikana.	Moottori on ylikuumentunut.	Tarkista, että kone ei ole kuristettu ja odota, kunnes kone on jäähtynyt (n. 30 min).
Kone puhaltaa ulos pölyä.	Suodatin on löystynyt tai rikkoutunut.	Tarkasta ja vaihda tarvittaessa.
Koneesta kuuluu epänormaalia ääntä.		Tilaa huolto.

EY-vaatimustenmukaisuusvakuutus

Täten todistamme, että DC Chip Extractor on seuraavien määräysten ja standardien mukainen:

2006/42/EC, 2014/30/EU, 2014/35/EU, EN 60204-1:2018, EN1822-1:2019.

Dustcontrol AB



Nina Uggowitzer / CEO & Technical Manager

2024-09-30

Ota yhteyttä

Dustcontrol Worldwide



AT
Dustcontrol Ges.m.b.H.
info@dustcontrol.at
www.dustcontrol.at



AU
All Preparation Equipment
www.allprep.com.au



BENELUX
Dust Solutions BV
www.dustsolutions.nl



BG
Metaltech14 Ltd.
metaltech14@abv.bg
www.dustcontrolbg.com



CA Dustcontrol
Canada Inc.
info@dustcontrol.ca
www.dustcontrol.ca



CH
Rosset Technik Maschinen
Werkzeuge AG
info@rosset-technik.ch
www.rosset-technik.ch



CL
Beckart Tecnologia Ambiental S.A.
ambitec@ambitec.cl
www.ambitec.cl



CN
Suzhou Dustcollect Filtration
Technology Co. Ltd.
wang@dustcollect.cn
www.dustcollect.cn



CZ / SK Ener
Group CZ, S.R.O. Infolinka:
+420 602 795 800
info@energrou.cz
www.prumysloveodsavani.cz/



DE
Dustcontrol GmbH
info@dustcontrol.de
www.dustcontrol.de



DK
Construction – Erenfred Pedersen A/S
info@ep.dk
www.ep.dk

Industry – Dansk Procesventilation ApS
info@dansk-procesventilation.dk
www.dansk-procesventilation.dk



EE
G-Color Baltic OÜ
sales@g-color.ee
www.g-color.ee



ES
Barin, s.a.
info@barin.es
www.barin.es



GB
Dustcontrol UK Ltd.
sales@dustcontrol.co.uk
www.dustcontrol.co.uk



GR
Mavrogiannakis S.A
ekttox@enternet.gr
www.ekttoxefits.com.gr



FI
Dustcontrol FIN OY
dc@dustcontrol.fi
www.dustcontrol.fi



FR
Construction – SMH Equipements
info@abequipements.com
www.smhequipements.com



Industry – Dustcontrol AB
info@dustcontrol.fra
www.dustcontrol.fra



HR
Kermek d.o.o.
kruno.nedeljko@kermek.com
www.kermek.com



HU
Vandras Kft
vandras@t-online.hu
www.vandras.hu



IN
Advance Ventilation Pve Ltd.
sales@advanceventilation.com
www.advanceventilation.com



IT
Airum srl
info@airum.com
www.airum.com



KR
ESH Engineering Co.
eshengco@gmail.com
www.eshengco.com



LT
UAB Hidromega
info@hidromega.lt
www.hidromega.lt



LV
SIA Reaktivs
reaktivs@reaktivs.lv
www.reaktivs.lv



MY, ID
Städa Enviroospace Bhd
info@stada.com.my
www.stada.com.my



NO
Teijo Norge A.S
firmapost@teijo.no
www.teijo.no



NZ
Artizan Diamond Tools
enquiry@artizandiamond.co.nz
www.artizandiamond.co.nz



PE
Efixo
contacto@efixo.pe
www.efixo.pe



PH
Sweden Concrete Machines Inc.
peringe@packoskick.se
www.swedenconcretemachines.ph



PL
Bart Sp. z o.o.
info@bart-vent.pl
www.bart-vent.pl



PT
Metec-Mecano Técnica, Lda.
geral@metec.pt
www.metec.pt



RO
AWS Elektrotehnik
office@awstehnik.ro
www.awstehnik.ro



General Contractor Industry SRL
office@gci-grup.ro
www.gci-grup.ro



RS
Enel Alati
eneldoo@eunet.rs
www.eneldoo.rs



RU
Centre Vacuum System
panov.g@movers-td.com
www.dustcontrolrus.ru



SE
Dustcontrol AB
info@dustcontrol.se
www.dustcontrol.com



SG
Städa Enviroospace Pte Ltd
Info@stada.com.my
www.stada.com.my



TW
Goodland Enterprise Co., Ltd.
sales@goodland.com.tw
www.goodland.com.tw



TH
MCON Intertrade Co., Ltd.
sales@mconintertrade.com
www.mconintertrade.com



TR Ventek
Mühendislik Ltd.
info@ventek.com.tr
www.ventek.com.tr



AE
Global Enterprises Trading Co L.L.C.
sales@globalentco.com
www.globalentco.com



GEM
Industrial Equipment Trading Co. Tel:
+971 4 8840 474
Email: gemuae@eim.ae



UA
MBK Obshemashkontrakt, JSC
zao@omk.dp.ua
www.omk.dp.ua



US
Dustcontrol Inc.
info@dustcontrolusa.com
www.dustcontrol.us



VN
Tayhostar JSC
tayhostar@tayhostar.vn
www.tayhostar.vn

Please contact the head office
in Sweden if you do not find a
distributor in your area.
info@dustcontrol.se

Juridisk varsel

**NOTAT**

Oversettelse av den originale brukerhåndboken

**VIKTIG**

Les bruksanvisningen før du bruker maskinen.

**VIKTIG**

Dustcontrol forbeholder seg retten til å endre spesifikasjoner uten varsel og er ikke forpliktet til å endre tidligere leverte produkter. Dustcontrol er ikke ansvarlig for feil eller mangler i denne brukerhåndboken.

**VIKTIG**

Alle relevante statlige, regionale og lokale sikkerhetsforskrifter må følges når du installerer og bruker dette produktet. Av sikkerhetsgrunner og for å sikre samsvar med dokumenterte systemdata, er det kun produsenten som skal utføre komponentreparasjoner. Unnlattelse av å følge denne informasjonen kan føre til personskade eller skade på utstyr.

**VIKTIG**

Alle rettigheter forbeholdt. Ingen del av denne publikasjonen kan reproduseres, distribueres eller overføres i noen form eller på noen måte, inkludert fotokopiering, opptak eller andre elektroniske eller mekaniske midler, uten skriftlig forhåndstillatelse fra utgiveren. For spørsmål om tillatelse, kontakt Dustcontrol.

**NOTAT**

Produktet er produsert av:

Dustcontrol AB
Box 3088, Kumla Gårdsväg 14
SE-145 03 Norsborg
Tel: +46 8 531 940 00
support@dustcontrol.se
www.dustcontrol.com

Sikkerhetsforskrifter

Intro

Les følgende sikkerhetsinstruksjoner før du starter denne maskinen. Lagre bruksanvisningen. Dersom sikkerhetsforskriftene ikke følges, gjelder ikke garantien. Person- og produktskade kan også oppstå. Dustcontrol er ikke ansvarlig for skade på utstyret forårsaket av feil installasjon eller feil håndtering av utstyret.

Advarsel

Denne maskinen er kun beregnet for profesjonell bruk.

Barn må være under tilsyn for å sikre at de ikke leker med maskinen.

Bruk kun originalt tilbehør og forbruksvarer som er inkludert i Dustcontrols sortiment.



ADVARSEL

Bruk maskinen til de oppgavene den er konstruert for. Følg forskriftene for materialet som skal suges opp.



ADVARSEL

Denne maskinen skal kun brukes til å suges opp tørt materiale.



ADVARSEL

Ved bruk av elektriske enheter må man følge grunnleggende sikkerhetsforskrifter for å redusere risikoen for brann, elektrisk støt og personskade.



ADVARSEL

Det må ikke suges varme, glødende partikler eller andre antenningskilder inn i maskinen. Maskinen må ikke brukes til eksplosive, ustabile eller selvantennende partikler.



ADVARSEL

Ved bruk av feil artikler eller kopier (først og fremst filtre, slanger og plastsekker), kan maskinen lekke helseskadelig støv, noe som kan føre til personskader.

Miljøvern

Resirkuler emballasje og inkluderte komponenter i henhold til lokale forskrifter. For mer informasjon, kontakt din nærmeste gjenvinningsstasjon eller Dustcontrol for maskinskrotning.

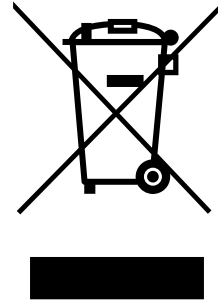
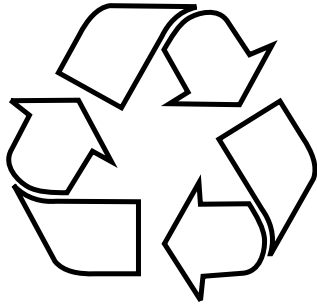

WEEE (Waste of Electric and Electronic Equipment)

Gjelder bare i EU-land: Elektrisk verktøy skal ikke kastes i husholdningsavfallet. Ifølge direktivet 2002/96/EF, som gjelder eldre elektrisk og elektronisk utstyr og deres bruk i samsvar med nasjonal lovgivning, skal brukt elektrisk verktøy sorteres separat og leveres til gjenvinning.

Arbeidsmiljø

Ikke utsett maskinen for fuktighet. Den må ikke brukes på fuktige og våte steder, eller i nærheten av lettantennelige væsker eller gasser.



OBS

Maskinen skal kun brukes og oppbevares i tørt miljø.



OBS

Maskinen skal ikke skylles med vann.

Overbelastning



OBS

Ikke la maskinen arbeide strypt. Det medfører risiko for overoppheting.

Kroppsskader



ADVARSEL

Du må aldri forsøke å endre elektriske koblinger selv. Feil kan føre til livsfare.



ADVARSEL

Ikke la sugepunktene komme i kontakt med kroppsdeler. Det kraftige undertrykket kan skade hudens blodkar.

**ADVARSEL**

Bruk hansker ved montering, håndtering og transport av produktet.

Elektrisk kabel

**ADVARSEL**

Ikke dra maskinen etter strømledningen. Ikke utsett strømledningen for varme eller skarpe gjenstander. Kontroller strømledningen regelmessig.

Ved skjøting av strømledningen må skjøteledningen være vanntett.

Maskinen skal ikke brukes hvis strømledningene eller kontaktene er skadet.

Hvis strømledningen er skadet, må den byttes av Dustcontrol eller ett av Dustcontrols godkjente serviceverksteder.

Viktig handling

Før du rengjør eller utfører vedlikehold på maskinen, må du slå av hovedstrømbryteren og koble maskinen fra strømmettet.

Denne maskinen må kun brukes hvis alle filtre er uskadde og riktig montert.

Omsorg

Hold maskinen ren og fri fra støvbelegg. Påse at sugeslangen er hel, og at alle tetninger er hele og uten feil. Hold bærehåndtakene tørre og fri for olje og fett.

Kontroll

Kontroller regelmessig at enheten ikke er skadet eller slitt. Hvis det oppstår skader, skal de repareres av Dustcontrols servicetekniker eller av et verksted som Dustcontrol har godkjent.

Funksjonsbeskrivelse

Støvsamleren jobber med undertrykk (sug) som driver luften gjennom sugehette/dyse, slangesystem og for- og støvutskiller. Grovseparasjon skjer i enhetens syklon, som er en meget effektiv separering av stadig grovere støv. Finstøvet separeres i enhetens filter. Filterrens med luftpuls gir filtrene ekstra lang levetid. Maskinen er utstyrt med HEPA-filtre.

DC Tromb 400 brukes til punktsuging (med maksimal stryping Ø 15 mm) til mange oppgaver, for eksempel ved sliping, sveising, personlig sanering og rengjøring. DC Tromb 400 drives av to en-fase, totrinns vifter.

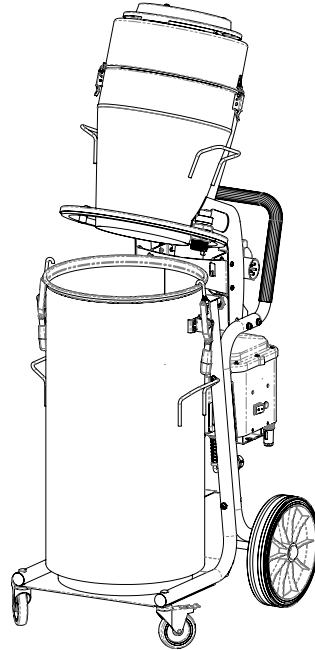
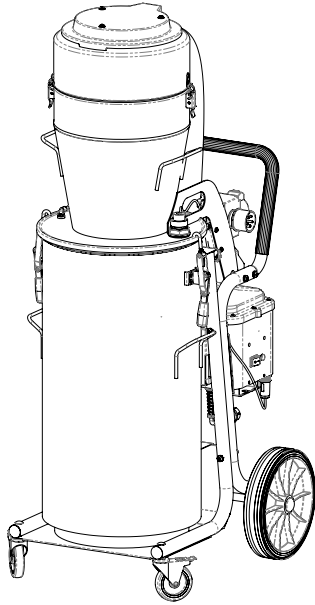

Støvsamleren har følgende utslippsmulighet:

a- Beholder: En sylindrisk beholder for oppsamling av utskilt materiale.

Tekniske data

Tekniske data	DC Chip Extractor
H x B x D [mm]	1530 x 600 x 780
Vekt [kg]	70
Innløp Ø [mm]	76
Slangelengde Ø50mm [m]	7.5
Oppsamlingsbeholder [l]	90
Strømningsmaks. vifte (EU) 230V [w ³ /h]	355
Undertrykk maks. [kPa]	22
Strømuttak (EU) 230V [W]	2600
Finfilter polyester, areal [m ²]	1.85
Utskillegrad finfilter, EN 60335-2-69, klasse M [%]	99.9
Filteroverflate mikrofilter [m ²]	2.2
Filterklassifisering, EN 1822-1	HEPA H13
Utskillegrad maskin, EN 60335-2-69, vedlegg A-A, klasse H [%]	99.995
Lydnivå [dB(A)]	70
Artikkelnr.	174100

Operasjon

Tilkobling

Koble maskinen til en stikkontakt med spenning som tilsvarer spesifikasjonene på maskinens merkeplate.

Automatisk starter (ALV10)

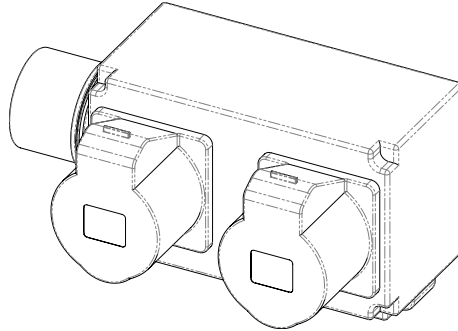

I henhold til gjeldende sikkerhetsforskrifter ved arbeid med trebearbeidingsmaskiner skal farlig støv suges effektivt opp av en sponavtrekker.

Denne starteren med tidsforsinkelse starter automatisk sponavtrekkeren etter 2-3 sekunder og beskytter derfor mot overbelastning på sikringen.

Etter at maskinen er stoppet, fortsetter sponvakuemet i ytterligere 3-4 sekunder og suger dermed opp det gjenværende støvet fra slangene.

Rengjøring av filter

Maskinen har en filterindikator som lyser når filteret må rengjøres eller skiftes.

Instruksjoner for filterrengjøring

1. La maskinen stå på, tilbakestill filterrengjøringsknappen og lukk spjeldet på sykloninntaket.
2. Vent 5-10 pulser.
3. Slå av maskinen.
4. Tilbakestill filterrengjøringsknappen og åpne spjeldet på sykloninntaket.
5. Start maskinen. Kontroller at filterindikatorlampen er av. Hvis ikke - gjenta prosedyren. Hvis lampen lyser selv etter repetisjonen, må finfilteret skiftes.

Filter Lamp 

- 1 
- 2 

"Poff..."
5 - 10 times
- 3 **POWER OFF**
- 4 
- 5 **POWER ON** → Filter Lamp 

Drenere



NOTAT

Nivåsensorer varsler når fatet er fullt og må tømmes.

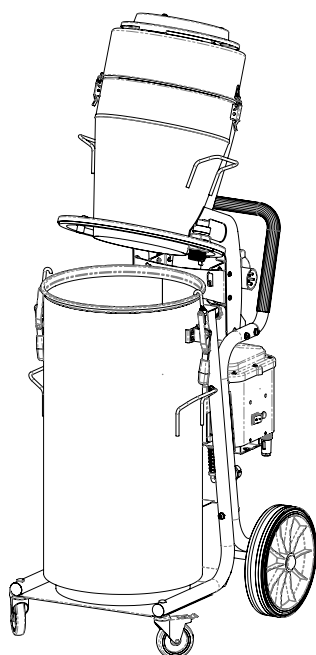

1. Løsne klipsene som fester lokket til tønnen.
2. Løft baksiden av syklonen ved hjelp av håndtakene på siden av syklonen. Se bildet ovenfor for syklonens posisjon.
3. Ved behov kan tønnen løftes fra chassiset.
4. Løft ut og knyt plastposen. Sett inn en ny plastpose.
5. Flytt syklonen tilbake på løpet og stram spennene.

Service/vedlikehold

Rengjøring

Ved rengjøring og vedlikehold av maskinen må maskinen slås av og støpselet trekkes ut.

Bytte filter

Finfilteret må byttes minst én gang i året. Bruk originalt filter. HEPA-filter skal byttes etter 300 timer.



ADVARSEL

Filterbytte skal kun utføres av personell som har fått instruksjoner i hvordan det skal gjøres. Bruk maske og egnet utstyr.



OBS

Ved filterbytte må det ikke brukes verktøy, da det kan skade filterets tetningsflate.

1. Løsne og løft av den øvre delen for å få fri tilgang til filteret.

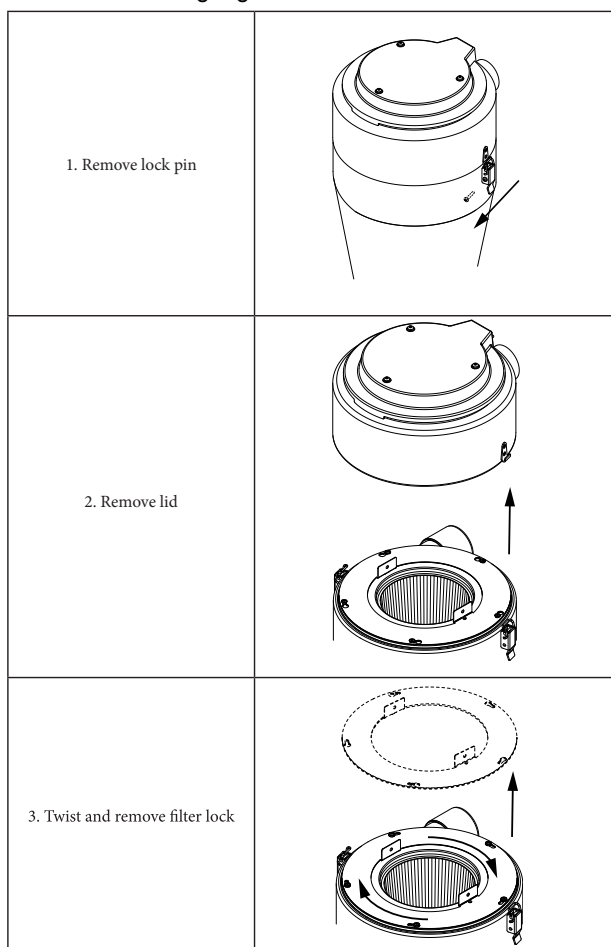

- 2.
3. Legg den medfølgende plastposen over syklonen for å hindre at støvet i filteret sprer seg.
4. Løft filteret rett opp.

5. Forsegl plastposen med det brukte filteret.

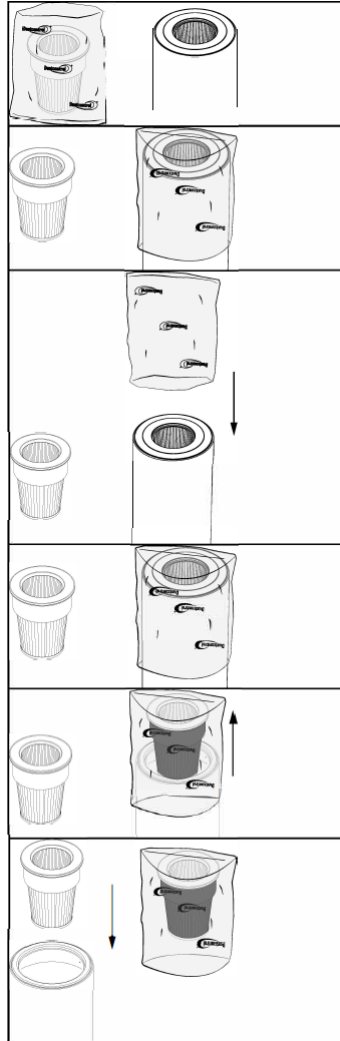

6.
 7. Når du skifter filter, sjekk pakningen.
 8. En lekk pakning kan forårsake frigjøring av helsefarlig støv.
 9. Bruk aldri gamle pakninger eller plagierte filtre.
 10. Utskiftede filtre må legges i en gjenlukkbart plastpose.

Motor

For viftemotorer er normal levetid for originalbørste 600–700 timer. Børsten kan byttes. For den andre børstepakken er levetiden cirka 400 timer, og for den tredje børstepakken er levetiden cirka 300 timer. Deretter er kollektoren utslitt, og motoren må byttes.

Overoppheting

Hvis maskinen står i fare for å bli overopphetet (for eksempel ved kraftig stryping), løser temperaturvakten ut, og maskinen stopper. Det er da viktig at operatøren trykker strømbryteren til AV-posisjon, trekker støpselet ut av stikkontakten og venter i 3–5 minutter, slik at maskinen rekker å avkjøles. Deretter tilbakestilles temperaturvakten ved å trykke inn knappen RESET. Koble støpselet til stikkontakten igjen, og start maskinen på nytt ved å trykke strømbryteren til PÅ.

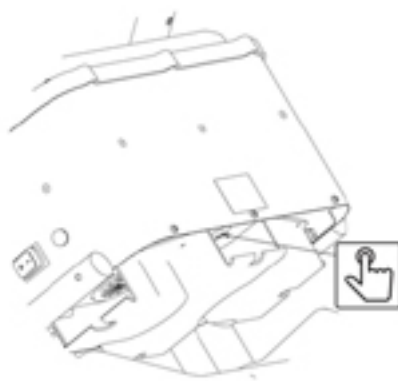

Regelmessig sjekk

Kontroller regelmessig at strømledningen ikke har blitt skadet.

Tilbehør og forbruksvarer

Betegnelse	Artikkelnr.
Tilkoblingsmuffe	2008
Tilkoblingsmuffe	2129
Slange Ø = 50	2013
HEPA filter	44016
Fint filter polyester	44017
Plastsekk, 50 stk.	4314
MOTOR 1285W 230V 50/60Hz	42309-01

Du finner reservedeler på [Dustcontrols nettsted](#).

Garanti

Garantiperioden er to år og dekker fabrikkasjonsfeil. Garantien gjelder forutsatt at maskinen brukes på normal måte, og får nødvendig service. Normal slitasje dekkes ikke. Reparasjoner skal utføres av Dustcontrol eller en person som Dustcontrol har godkjent. Ellers bortfaller garantien.

Motor

Motoren(e) til produktet dekkes ikke av garantien. Prøvelevetid for en motor kan være mellom 600 - 700 driftstimer. Kontakt Dustcontrol hvis du trenger å bytte motor.

Feilsøking

Problem	Arsak	Tiltak
Motoren går ikke.	Strøm er ikke tilkoblet.	Koble til strøm.
Motoren stopper umiddelbart etter start.	Feil sikring.	Bytt til riktig sikring.
Motoren går, men maskinen suger ikke.	Sugeslange er ikke tilkoblet.	Koble til slangen.
Motoren går, men maskinen suger svakt.	Hull på sugeslangen.	Bytt slange.
	Tett filter.	Rens eller bytt.
	Sugeslangen er for lang eller trang.	Bytt slange.
	Slangen er delvis tett.	Snu slangen, eller rens den.
	Maskinens topp er dårlig montert.	Juster monteringen.
	Det sitter fast støv i syklonen.	Fjern toppen, og rens syklonen.
Motoren stopper under drift.	Motoren er overopphetet.	Sjekk at maskinen ikke er strupet og vent til maskinen er avkjølt (ca. 30min).
Maskinen blåser ut støv.	Filteret har løsnet eller blitt ødelagt.	Kontroller, og bytt ved behov.
Unormal lyd fra maskinen.		Bestill service.

EU-erklæring

Vi bekrefter herved at DC Chip Extractor er i samsvar med følgende forskrifter og standarder:

2006/42/EC, 2014/30/EU, 2014/35/EU, EN 60204-1:2018, EN1822-1:2019.

Dustcontrol AB



Nina Uggowitzner / CEO & Technical Manager

2024-09-30

Kontakt

Dustcontrol Worldwide



AT
Dustcontrol Ges.m.b.H.
info@dustcontrol.at
www.dustcontrol.at



AU
All Preparation Equipment
www.allprep.com.au



BENELUX
Dust Solutions BV
www.dustsolutions.nl



BG
Metaltech14 Ltd.
metaltech14@abv.bg
www.dustcontrolbg.com



CA Dustcontrol
Canada Inc.
info@dustcontrol.ca
www.dustcontrol.ca



CH
Rosset Technik Maschinen
Werkzeuge AG
info@rosset-technik.ch
www.rosset-technik.ch



CL
Beckart Tecnologia Ambiental S.A.
ambitec@ambitec.cl
www.ambitec.cl



CN
Suzhou Dustcollect Filtration
Technology Co. Ltd.
wang@dustcollect.cn
www.dustcollect.cn



CZ / SK Ener
Group CZ, S.R.O. Infolinka:
+420 602 795 800
info@energrou.cz
www.prumysloveodsavani.cz/



DE
Dustcontrol GmbH
info@dustcontrol.de
www.dustcontrol.de



DK
Construction – Erenfred Pedersen A/S
info@ep.dk
www.ep.dk
Industry – Dansk Procesventilation ApS
info@dansk-procesventilation.dk
www.dansk-procesventilation.dk



EE
G-Color Baltic OÜ
sales@g-color.ee
www.g-color.ee



ES
Barin, s.a.
info@barin.es
www.barin.es



GB
Dustcontrol UK Ltd.
sales@dustcontrol.co.uk
www.dustcontrol.co.uk



GR
Mavrogiannakis S.A
ekttox@enternet.gr
www.ekttoxefits.com.gr



FI
Dustcontrol FIN OY
dc@dustcontrol.fi
www.dustcontrol.fi



FR
Construction – SMH Equipements
info@abequipements.com
www.smhequipements.com



Industry – Dustcontrol AB
info@dustcontrol.fra
www.dustcontrol.fra



HR
Kermek d.o.o.
kruno.nedeljko@kermek.com
www.kermek.com



HU
Vandras Kft
vandras@t-online.hu
www.vandras.hu



IN
Advance Ventilation Pve Ltd.
sales@advanceventilation.com
www.advanceventilation.com



IT
Airum srl
info@airum.com
www.airum.com



KR
ESH Engineering Co.
eshengco@gmail.com
www.eshengco.com



LT
UAB Hidromega
info@hidromega.lt
www.hidromega.lt



LV
SIA Reaktivs
reaktivs@reaktivs.lv
www.reaktivs.lv



MY, ID
Städa EnviroSPACE Bhd
info@stada.com.my
www.stada.com.my



NO
Teijo Norge A.S
firmapost@teijo.no
www.teijo.no



NZ
Artizan Diamond Tools
enquiry@artizandiamond.co.nz
www.artizandiamond.co.nz



PE
Efixo
contacto@efixo.pe
www.efixo.pe



PH
Sweden Concrete Machines Inc.
peringe@packoskick.se
www.swedenconcretemachines.ph



PL
Bart Sp. z o.o.
info@bart-vent.pl
www.bart-vent.pl



PT
Metec-Mecano Técnica, Lda.
geral@metec.pt
www.metec.pt



RO
AWS Elektrotehnik
office@awstehnik.ro
www.awstehnik.ro

General Contractor Industry SRL
office@gci-grup.ro
www.gci-grup.ro



RS
Enel Alati
eneldoo@eunet.rs
www.eneldoo.rs



RU
Centre Vacuum System
panov.g@movers-td.com
www.dustcontrolrus.ru



SE
Dustcontrol AB
info@dustcontrol.se
www.dustcontrol.com



SG
Städa EnviroSPACE Pte Ltd
Info@stada.com.my
www.stada.com.my



TW
Goodland Enterprise Co., Ltd.
sales@goodland.com.tw
www.goodland.com.tw



TH
MCON Intertrade Co., Ltd.
sales@mconintertrade.com
www.mconintertrade.com



TR Ventek
Mühendislik Ltd.
info@ventek.com.tr
www.ventek.com.tr



AE
Global Enterprises Trading Co L.L.C.
sales@globalentco.com
www.globalentco.com

GEM
Industrial Equipment Trading Co. Tel:
+971 4 8840 474
Email: gemuae@eim.ae



UA
MBK Obshemashkontrakt, JSC
zao@omk.dp.ua
www.omk.dp.ua



US
Dustcontrol Inc.
info@dustcontrolusa.com
www.dustcontrol.us



VN
Tayhostar JSC
tayhostar@tayhostar.vn
www.tayhostar.vn

Please contact the head office
in Sweden if you do not find a
distributor in your area.
info@dustcontrol.se

Juridisk meddelelse



BEMÆRK

Oversættelse af den originale brugermanual



VIGTIGT

Læs brugervejledningen, før du bruger maskinen.



VIGTIGT

Dustcontrol forbeholder sig retten til at ændre specifikationer uden varsel og er ikke forpligtet til at ændre tidligere leverede produkter. Dustcontrol er ikke ansvarlig for fejl eller udeladelser i denne brugervejledning.



VIGTIGT

Alle relevante statslige, regionale og lokale sikkerhedsbestemmelser skal følges ved installation og brug af dette produkt. Af sikkerhedsmæssige årsager og for at sikre overholdelse af dokumenterede systemdata er det kun fabrikanten, der skal udføre komponentreparationer. Manglende overholdelse af disse oplysninger kan resultere i personskade eller beskadigelse af udstyr.



VIGTIGT

Alle rettigheder forbeholdes. Ingen del af denne publikation må reproduceres, distribueres eller transmitteres i nogen form eller på nogen måde, herunder fotokopiering, optagelse eller andre elektroniske eller mekaniske midler, uden forudgående skriftlig tilladelse fra udgiveren. For tilladelsesforespørgsler, kontakt Dustcontrol.



BEMÆRK

Produktet er fremstillet af:

Dustcontrol AB
Box 3088, Kumla Gårdsväg 14
SE-145 03 Norsborg
Tel: +46 8 531 940 00
support@dustcontrol.se
www.dustcontrol.com

Sikkerhedsbestemmelser

Intro

Læs følgende sikkerhedsinstruktioner, før du starter denne maskine. Gem brugervejledningen. Hvis sikkerhedsforskrifterne ikke overholdes, gælder garantien ikke. Der kan også opstå person- og produktskader. Dustcontrol er ikke ansvarlig for skader på udstyret forårsaget af forkert installation eller forkert håndtering af udstyret.

Advarsel

Denne maskine er kun beregnet til professionel brug.

Børn skal være under opsyn for at sikre, at de ikke leger med maskinen.

Brug kun originalt tilbehør og forbrugsstoffer, der er inkluderet i Dustcontrols sortiment.



ADVARSEL

Brug maskinen til det tilsigtede formål. Følg forskrifterne vedrørende det materiale, der opsuges.



ADVARSEL

Denne maskine er kun beregnet til opsugning af tørt materiale.



ADVARSEL

Ved brug af elektriske apparater skal de grundlæggende sikkerhedsforskrifter overholdes for at mindske risikoen for brand, elektrisk stød eller personskade.



ADVARSEL

Der må ikke suges varme, glødende partikler eller andre antændelseskilder ind i maskinen. Maskinen må ikke anvendes til eksplosive, ustabile eller selvantændelige partikler.



ADVARSEL

Ved anvendelse af defekte brugsartikler eller uoriginalt tilbehør (især filtre, slanger og plastsække) kan maskinen lække sundhedsskadeligt støv med personskade til følge.

Miljøbeskyttelse

Genbrug emballage og inkluderede komponenter i henhold til lokale regler. For mere information kontakt din nærmeste genbrugsstation eller Dustcontrol for maskinskrotning.

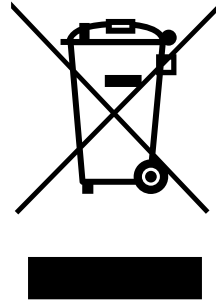
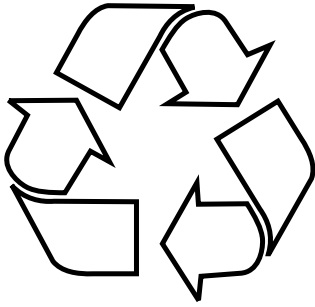

WEEE (Waste of Electric and Electronic Equipment)

Gælder kun EU-lande: Elektrisk værktøj må ikke bortskaffes som husholdningsaffald. Ifølge direktiv 2002/96/EF om affald af elektrisk og elektronisk udstyr og den nationale lovgivning til gennemførelse heraf skal udtjent elektrisk udstyr sorteres separat og afleveres til miljøvenlig genbrug.

Arbejds miljø

Maskinen må ikke udsættes for fugt. Må ikke anvendes i fugtige og våde områder eller i nærheden af letantændelige væsker eller gasser.



PAS PÅ

Denne maskine må kun anvendes og opbevares i et tørt miljø.



PAS PÅ

Maskinen må ikke skylles med vand.

Overbelaste



PAS PÅ

Lad ikke maskinen arbejde helt droslet, da det medfører fare for overophedning.

Kropsskader



ADVARSEL

Forsøg ikke at ændre de elektriske tilslutninger selv. En fejl kan medføre livsfare!



ADVARSEL

Lad aldrig sugepunktet komme i kontakt med nogen legemsdel. Det kraftige undertryk kan beskadige hudens blodkar.

**ADVARSEL**

Der skal anvendes beskyttelseshandsker ved montering, håndtering og transport af produktet.

Elektrisk kabel

**ADVARSEL**

Maskinen må ikke flyttes ved at trække i strømledningen. Udsæt ikke strømledningen for varme eller skarpe genstande. Kontrollér strømledningen regelmæssigt.

Når der anvendes et forlængerkabel, skal det sikres, at forbindelsen er vandtæt.

Maskinen må ikke anvendes, hvis strømledningerne eller kontakterne er beskadiget.

Hvis strømledningen er beskadiget, skal den udskiftes af Dustcontrol eller af et serviceværksted, som Dustcontrol har autoriseret.

Vigtig handling

Inden rengøring eller vedligeholdelse af maskinen skal du slukke for hovedafbryderen og tage maskinens stik ud af kontakten.

Denne maskine må kun bruges, hvis alle filtre er ubeskadigede og korrekt monteret.

Omsorg

Maskinen skal holdes ren og fri for støvaflejringer. Sørg for, at sugeslangen er intakt, og at alle tætninger er intakte og fejlfri. Hold bærehåndtagene tørre og fri for olie og fedt.

Kontrollere

Kontrollér regelmæssigt enheden for skader og slitage. Opstår der skader, skal de udbedres af Dustcontrols servicetekniker eller af et serviceværksted, som er autoriseret af Dustcontrol.

Funktionsbeskrivelse

Støvsamleren arbejder med undertryk (suge) som driver luften gennem sugehætte/mundstykke, slangesystem og for- og støvudskiller. Grovseparatoring foregår i enhedens cyklon, som er en meget effektiv adskillelse af stadigt grovere støv. Det fine støv udskilles i enhedens filter. Filterrensning med luftpuls giver filtrene ekstra lang levetid. Maskinen er udstyret med HEPA-filtre.

DC Tromb 400 anvendes til punktudsugning (med maksimal forsnævring på Ø 15 mm) i mange sammenhænge, f.eks. ved slibning, svejsning, personlig sanering og rengøring. DC Tromb 400 drives af to 1-fasede 2-trinsventilatorer.

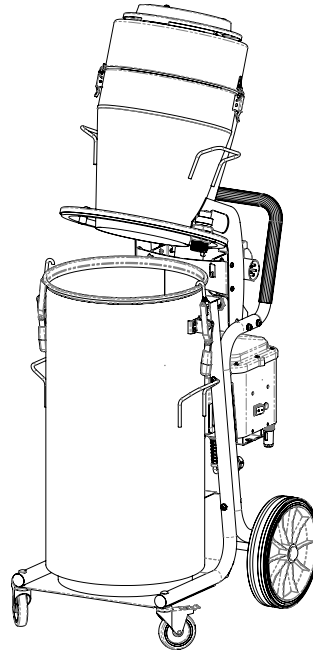
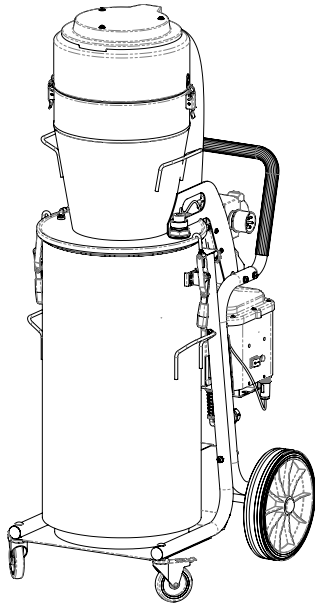

Støvsamleren har følgende udledningmulighed:

a – Beholder: En cylindrisk beholder til opsamling af udskilt materiale.

Tekniske data

Tekniske data	DC Chip Extractor
H x B x D [mm]	1530 x 600 x 780
Vægt [kg]	70
Indløbs-Ø [mm]	76
Slangelængde Ø50mm [m]	7.5
Opsamlingsbeholder [l]	90
Flow max. ventilator (EU) 230V [w ³ /h]	355
Undertryk maks. [kPa]	22
Strømodtag (EU) 230V [W]	2600
Finfilter polyester, areal [m ²]	1.85
Udskilningsgrad finfilter, EN 60335-2-69, klasse M [%]	99.9
Filterareal mikrofilter [m ²]	2.2
Filterklassificering, EN 1822-1	HEPA H13
Maskinens udskilningsgrad, EN 60335-2-69, bilag A-A, klasse H [%]	99.995
Lydniveau [dB(A)]	70
Art.-nr.	174100

Operation

Tilslutning

Tilslut maskinen til et eludtag med spænding i henhold til specifikationerne på maskinens mærkeplade.

Automatisk starter (ALV10)

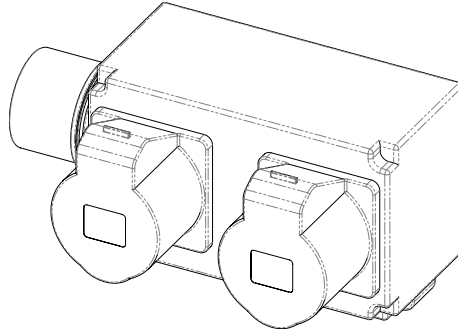

I henhold til gældende sikkerhedsregler ved arbejde med træbearbejdningsmaskiner skal farligt støv effektivt suges op af en spånsuger.

Denne starter med tidsforsinkelse starter automatisk spånudsugningen efter 2-3 sekunder og beskytter derfor mod overbelastning af sikringen.

Efter at maskinen er stoppet, fortsætter spånvakuet i yderligere 3-4 sekunder og suger dermed det resterende støv op fra slangerne.

Filterrensning

Maskinen har en filterindikator, der lyser, når filteret skal renses eller udskiftes.

Vejledning til filterrensning

1. Lad maskinen være tændt, nulstil filterrengøringsknappen og luk spjældet på cyklonens indløb.
2. Vent 5-10 pulser.
3. Sluk for maskinen.
4. Nulstil filterrengøringsknappen og åbn spjældet på cyklonens indløb.
5. Start maskinen. Kontroller, at filterindikatoren er slukket. Hvis ikke - gentag proceduren. Hvis lampen lyser selv efter gentagelsen, skal finfilteret udskiftes.



Dræne



BEMÆRK

Niveausensorer advarer, når tønden er fuld og skal tømmes.

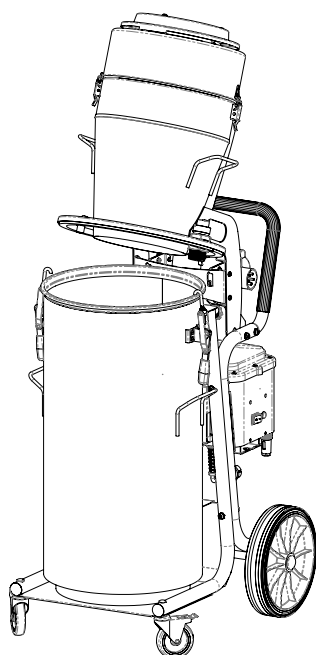

1. Løsn clipsene, der fastgør låget til tønden.
2. Løft bagsiden af cyklonen ved hjælp af håndtagene på siden af cyklonen. Se ovenstående billede for cyklonens position.
3. Om nødvendigt kan tønden løftes fra chassiset.
4. Løft ud og bind plastikposen. Indsæt en ny plastikpose.
5. Flyt cyklonen tilbage på løbet og stram spænderne.

Service/vedligeholdelse

Rengøring

Ved rengøring og vedligeholdelse af maskinen skal du slukke for maskinen og trække stikket ud.

Filterskift

Finfiltret skal udskiftes mindst én gang om året. Der må kun anvendes originale filtre. HEPA-filtret skal udskiftes efter 300 timer.



ADVARSEL

Udskiftning af filtret må kun udføres af uddannet personale. Brug beskyttelsesmaske og egnet udstyr.



PAS PÅ

Ved udskiftning af filtret må der ikke anvendes værktøj/redskaber, da disse kan beskadige filtrets tætningsflade.

1. Løsn og løft den øverste del af for at få fri adgang til filteret.

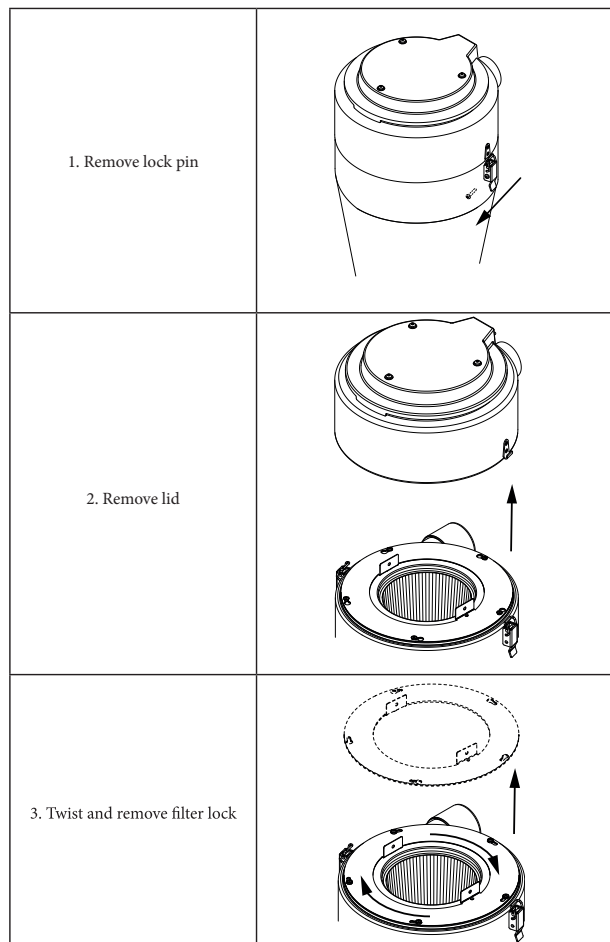

- 2.

3. Læg den medfølgende plastikpose over cyclonen for at forhindre, at støvet i filteret spreder sig.
4. Løft filteret lige op.
5. Forsegl plastikposen med det brugte filter.

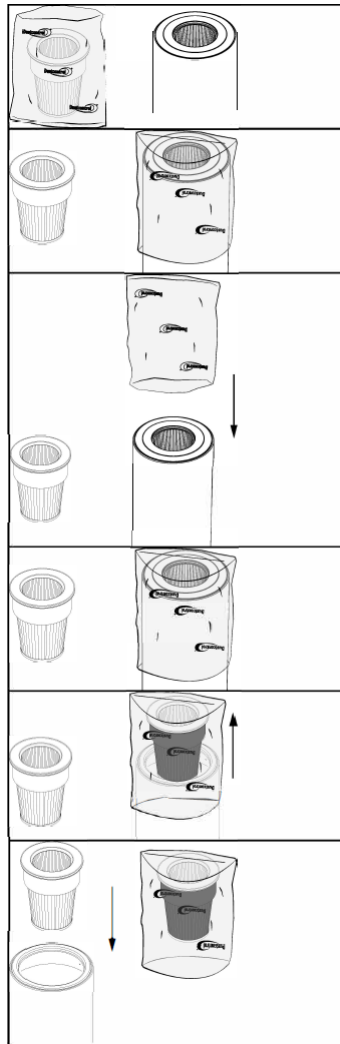

- 6.
7. Når du skifter filter, skal du kontrollere pakningen.
8. En utæt pakning kan forårsage frigivelse af sundhedsfarligt støv.
9. Brug aldrig gamle pakninger eller plagierede filtre.
10. Udskiftede filtre skal placeres i en genlukkelig plastikpose.

Motor

For ventilatormotorer er den typiske levetid for originale børster 600-700 timer. Børsten kan udskiftes. For den anden børstepakke er levetiden ca. 400 timer og for den tredje børstepakke ca. 300 timer. Herefter er kollektoren slidt op, og motoren skal udskiftes.

Overophedning

Hvis maskinen er i fare for at blive overophedet (f.eks. ved kraftig drosling), udløses temperaturvagten, og maskinen stopper. Så er det vigtigt, at operatøren slår strømafbryderen fra, trækker ledningen ud af stikkontakten og venter 3-5 minutter, så maskinen når at afkøle. Derefter nulstilles temperaturvagten ved at trykke på RESET-knappen. Tilslut ledningen til eludtaget, og genstart maskinen ved at slå strømafbryderen til.

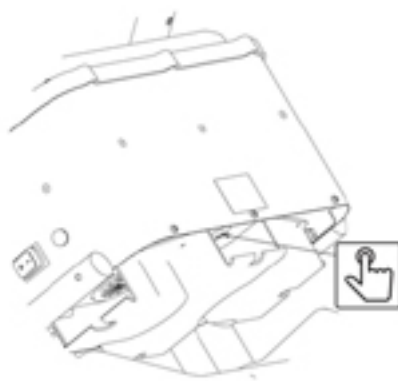

Regelmæssig kontrol

Kontrollér regelmæssigt, at strømledningen ikke er beskadiget.

Tilbehør og forbrugsvarer

Betegnelse	Art. nr.
Tilslutningsmuffe	2008
Tilslutningsmuffe	2129
Slange Ø = 50	2013
HEPA filter	44016
Fint filter polyester	44017
Plastsæk, 50 stk.	4314
MOTOR 1285W 230V 50/60Hz	42309-01

Reservedele kan ses på [Dustcontrols hjemmeside](#).

Garanti

Garantiperioden er to år og dækker fabrikationsfejl. Garantien gælder, forudsat at maskinen anvendes på normal vis og får den nødvendige service. Normal slitage erstattes ikke. Reparationer skal udføres af Dustcontrol eller af personer, som er godkendt af Dustcontrol. Ellers bortfalder garantien.

Motor

Produktets motor(er) er ikke dækket af garantien. Prøvelevetid for en motor kan være mellem 600 - 700 driftstimer. Kontakt Dustcontrol, hvis du skal skifte motor.

Fejlfinding

Problem	Årsag	Afhjælpning
Motoren kører ikke.	Der er ikke tilsluttet strøm.	Tilslut strøm.
Motoren stopper lige efter start.	Forkert sikring.	Skift til korrekt sikring.
Motoren kører, men maskinen suger ikke.	Sugeslangen er ikke tilsluttet. Blokering i slangen.	Tilslut slangen. Vend slangen, eller rens den.
Motoren kører, men maskinen suger dårligt.	Hul på sugeslangen.	Skift slange.
	Tilstoppet filter.	Rens eller udskift den.
	Sugeslangen er for lang eller smal.	Skift slange.
	Slangen er delvist tilstoppet.	Vend slangen, eller rens den.
	Maskinens overdelt er dårligt monteret.	Juster monteringen.
	Der sidder støv fast i cyklonen.	Tag overdelen af, og rengør cyklonen.
Motoren stopper under drift.	Motoren er overophedet.	Tjek at maskinen ikke er drøstet og vent til maskinen er kølet af (ca. 30min).
Maskinen blæser støv ud.	Filtret har løsnet sig eller er gået i stykker.	Kontrollér det, og udskift det efter behov.
Unormal lyd fra maskinen.		Bestil service.

EF-overensstemmelseserklæring

Vi bekræfter hermed, at DC Chip Extractor er i overensstemmelse med følgende regler og standarder:

2006/42/EC, 2014/30/EU, 2014/35/EU, EN 60204-1:2018, EN1822-1:2019.

Dustcontrol AB



Nina Uggowitzner / CEO & Technical Manager

2024-09-30

Kontakte

Dustcontrol Worldwide



AT
Dustcontrol Ges.m.b.H.
info@dustcontrol.at
www.dustcontrol.at



AU
All Preparation Equipment
www.allprep.com.au



BENELUX
Dust Solutions BV
www.dustsolutions.nl



BG
Metaltech14 Ltd.
metaltech14@abv.bg
www.dustcontrolbg.com



CA Dustcontrol
Canada Inc.
info@dustcontrol.ca
www.dustcontrol.ca



CH
Rosset Technik Maschinen
Werkzeuge AG
info@rosset-technik.ch
www.rosset-technik.ch



CL
Beckart Tecnologia Ambiental S.A.
ambitec@ambitec.cl
www.ambitec.cl



CN
Suzhou Dustcollect Filtration
Technology Co. Ltd.
wang@dustcollect.cn
www.dustcollect.cn



CZ / SK Ener
Group CZ, S.R.O. Infolinka:
+420 602 795 800
info@energrou.cz
www.prumysloveodsavani.cz/



DE
Dustcontrol GmbH
info@dustcontrol.de
www.dustcontrol.de



DK
Construction – Erenfred Pedersen A/S
info@ep.dk
www.ep.dk

Industry – Dansk Procesventilation ApS
info@dansk-procesventilation.dk
www.dansk-procesventilation.dk



EE
G-Color Baltic OÜ
sales@g-color.ee
www.g-color.ee



ES
Barin, s.a.
info@barin.es
www.barin.es



GB
Dustcontrol UK Ltd.
sales@dustcontrol.co.uk
www.dustcontrol.co.uk



GR
Mavrogiannakis S.A
ekttox@enternet.gr
www.ekttoxefits.com.gr



FI
Dustcontrol FIN OY
dc@dustcontrol.fi
www.dustcontrol.fi



FR
Construction – SMH Equipements
info@abequipements.com
www.smhequipements.com



Industry – Dustcontrol AB
info@dustcontrol.fra
www.dustcontrol.fra



HR
Kermek d.o.o.
kruno.nedeljko@kermek.com
www.kermek.com



HU
Vandras Kft
vandras@t-online.hu
www.vandras.hu



IN
Advance Ventilation Pve Ltd.
sales@advanceventilation.com
www.advanceventilation.com



IT
Airum srl
info@airum.com
www.airum.com



KR
ESH Engineering Co.
eshengco@gmail.com
www.eshengco.com



LT
UAB Hidromega
info@hidromega.lt
www.hidromega.lt



LV
SIA Reaktivs
reaktivs@reaktivs.lv
www.reaktivs.lv



MY, ID
Städa EnviroSPACE Bhd
info@stada.com.my
www.stada.com.my



NO
Teijo Norge A.S
firmapost@teijo.no
www.teijo.no



NZ
Artizan Diamond Tools
enquiry@artizandiamond.co.nz
www.artizandiamond.co.nz



PE
Efixo
contacto@efixo.pe
www.efixo.pe



PH
Sweden Concrete Machines Inc.
peringe@packoskick.se
www.swedenconcretemachines.ph



PL
Bart Sp. z o.o.
info@bart-vent.pl
www.bart-vent.pl



PT
Metec-Mecano Técnica, Lda.
geral@metec.pt
www.metec.pt



RO
AWS Elektrotehnik
office@awstehnik.ro
www.awstehnik.ro



General Contractor Industry SRL
office@gci-grup.ro
www.gci-grup.ro



RS
Enel Alati
eneldoo@eunet.rs
www.eneldoo.rs



RU
Centre Vacuum System
panov.g@movers-td.com
www.dustcontrolrus.ru



SE
Dustcontrol AB
info@dustcontrol.se
www.dustcontrol.com



SG
Städa EnviroSPACE Pte Ltd
Info@stada.com.my
www.stada.com.my



TW
Goodland Enterprise Co., Ltd.
sales@goodland.com.tw
www.goodland.com.tw



TH
MCON Intertrade Co., Ltd.
sales@mconintertrade.com
www.mconintertrade.com



TR Ventek
Mühendislik Ltd.
info@ventek.com.tr
www.ventek.com.tr



AE
Global Enterprises Trading Co L.L.C.
sales@globalentco.com
www.globalentco.com



GEM
Industrial Equipment Trading Co. Tel:
+971 4 8840 474
Email: gemuae@eim.ae



UA
MBK Obshemashkontrakt, JSC
zao@omk.dp.ua
www.omk.dp.ua



US
Dustcontrol Inc.
info@dustcontrolusa.com
www.dustcontrol.us



VN
Tayhostar JSC
tayhostar@tayhostar.vn
www.tayhostar.vn

Please contact the head office
in Sweden if you do not find a
distributor in your area.
info@dustcontrol.se

Juridische mededeling



LET OP

Vertaling van de originele gebruikershandleiding



BELANGRIJK

Lees de gebruikershandleiding voordat u de machine gebruikt.



BELANGRIJK

Dustcontrol behoudt zich het recht voor om specificaties zonder voorafgaande kennisgeving te wijzigen en is niet verplicht eerder geleverde producten te wijzigen. Dustcontrol is niet verantwoordelijk voor fouten of weglatingen in deze gebruikershandleiding.



BELANGRIJK

Bij de installatie en het gebruik van dit product moeten alle relevante staats-, regionale en lokale veiligheidsvoorschriften worden nageleefd. Om veiligheidsredenen en om te garanderen dat de gedocumenteerde systeemgegevens worden nageleefd, mag alleen de fabrikant reparaties aan onderdelen uitvoeren. Het niet opvolgen van deze informatie kan leiden tot persoonlijk letsel of schade aan apparatuur.



BELANGRIJK

Alle rechten voorbehouden. Niets uit deze publicatie mag worden gereproduceerd, gedistribueerd of verzonden in welke vorm of op welke manier dan ook, inclusief fotokopiëren, opnemen of andere elektronische of mechanische middelen, zonder voorafgaande schriftelijke toestemming van de uitgever. Neem voor vragen over vergunningen contact op met Dustcontrol.



LET OP

Het product is vervaardigd door:

Dustcontrol AB
Box 3088, Kumla Gårdsväg 14
SE-145 03 Norsborg
Tel: +46 8 531 940 00
support@dustcontrol.se
www.dustcontrol.com

Veiligheidsvoorschriften

Intro

Lees de volgende veiligheidsinstructies voordat u deze machine start. Bewaar de gebruikershandleiding. Indien de veiligheidsvoorschriften niet worden nageleefd, is de garantie niet van toepassing. Ook persoonlijke en productschade kan voorkomen. Dustcontrol is niet verantwoordelijk voor schade aan de apparatuur veroorzaakt door onjuiste installatie of onjuiste omgang met de apparatuur.

Waarschuwing

Deze machine is uitsluitend bedoeld voor professioneel gebruik.

Kinderen moeten onder toezicht staan om ervoor te zorgen dat ze niet met de machine spelen.

Gebruik alleen originele accessoires en verbruiksartikelen die in het assortiment van Dustcontrol zijn opgenomen.



WAARSCHUWING

Gebruik de machine waarvoor deze bedoelde is. Volg de voorschriften voor het materiaal dat opgezogen wordt.



WAARSCHUWING

Deze machine is uitsluitend bedoeld voor het opzuigen van droog materiaal.



WAARSCHUWING

Bij gebruik van elektrische apparaten moeten elementaire veiligheidsmaatregelen in acht worden genomen om het risico van brand, elektrische schokken of lichamelijk letsel te verkleinen.



WAARSCHUWING

Er mogen geen hete, gloeiende deeltjes of andere ontstekingsbronnen in de machine worden gezogen. De machine mag niet worden gebruikt voor explosieve, instabiele of zelfontbrandende deeltjes.



WAARSCHUWING

Indien verkeerde of nagemaakte producten gebruikt worden (met name filter, slangen en plastic zakken) kan er stof uit de machine lekken dat gevaarlijk voor de gezondheid kan zijn, met persoonlijk letsel tot gevolg.

Milieubescherming

Recycle de verpakking en de meegeleverde componenten volgens de lokale regelgeving. Neem voor meer informatie contact op met het dichtstbijzijnde recyclingcentrum of met Dustcontrol voor het slopen van machines.

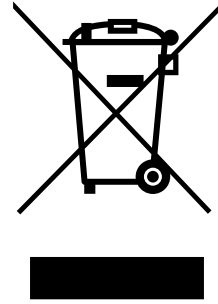
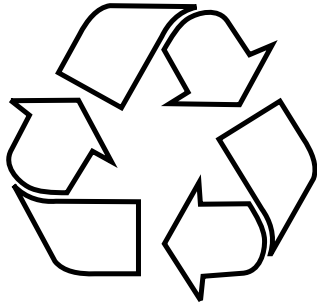

WEEE (Waste of Electric and Electronic Equipment), ofwel AEEA: Afval van elektrische en elektronische apparatuur

Geldt uitsluitende voor EU-landen: Elektrische apparaten mogen niet als huishoudelijk afval worden verwijderd. Volgens Richtlijn 2002/96/EG betreffende oudere elektrische en elektronische apparatuur en de toepassing ervan volgens nationale regelgeving, moeten afgedankte elektrische apparaten apart worden gesorteerd en voor milieuvriendelijke recycling worden aangeboden.

Werkomgeving

Stel de machine niet bloot aan vocht. Niet gebruiken in vochtige en natte ruimten of in de nabijheid van ontvlambare vloeistoffen of gassen.



LET OP

Deze machine mag alleen gebruikt en opgeslagen worden in een droge omgeving.



LET OP

De machine mag niet met water worden afgespoeld.

Overbelasting



LET OP

Laat de machine nooit draaien als deze verstopt is aangezien dit een kans op oververhitting oplevert.

Lichamelijke verwondingen



WAARSCHUWING

Probeer nooit zelf elektrische verbindingen te wijzigen. Een fout kan levensgevaar opleveren!



WAARSCHUWING

Zorg dat het zuigmondstuk nooit in contact komt met een lichaamsdeel. De sterke onderdruk kan bloedvaten in de huid beschadigen.



WAARSCHUWING

Bij het monteren, hanteren en vervoeren van het product moeten beschermende handschoenen worden gebruikt.

Elektrische kabel



WAARSCHUWING

Trek de machine nooit aan het netsnoer voort. Zorg dat het netsnoer niet beschadigd raakt door warmte en scherpe voorwerpen. Controleer het netsnoer regelmatig.

Bij het verlengen van het netsnoer, moet het verlengsnoer waterbestendig zijn.

De machine mag niet worden gebruikt als het netsnoer of de stekker beschadigd zijn.

Als het netsnoer beschadigd is, moet het worden vervangen door Dustcontrol of door een door Dustcontrol geautoriseerde werkplaats.

Belangrijke actie

Voordat u de machine gaat schoonmaken of er onderhoud aan gaat plegen moet u de hoofdschakelaar uitzetten en de machine van het net loskoppelen.

Deze machine mag alleen worden gebruikt als alle filters onbeschadigd zijn en correct zijn gemonteerd.

Zorg

Houd de machine schoon en vrij van stofafzettingen. Let er op dat de zuigslang heel is en dat alle aansluitingen intact en foutvrij zijn. De draaghandgrepen moeten droog gehouden worden en vrij van olie en vet.

Controle

Controleer het apparaat regelmatig op schade of slijtage. Bij schade moet dit verholpen worden door een service-monteur van Dustcontrol of een door Dustcontrol geautoriseerde werkplaats.

Beschrijving van de werking

De stofafscheider werkt met onderdruk (aanzuiging) die de lucht door de afzuigkap/nozzle, slangstelsysteem en voor- en stofafscheider drijft. Grote afscheiding vindt plaats in de cycloon van de unit, een zeer efficiënte afscheiding van steeds grover stof. Het fijne stof wordt afgescheiden in het filter van het toestel. Filterreiniging met luchtpuls geeft de filters een extra lange levensduur. De machine is uitgerust met HEPA-filters.

De DC Tromb 400 wordt gebruikt voor puntafzuiging (met maximale vernauwing \varnothing 15 mm) in diverse situaties, bijv. bij slijpen, lassen, persoonlijke sanering en schoonmaken. De DC Tromb 400 heeft twee 1-fase 2-traps ventilatoren.

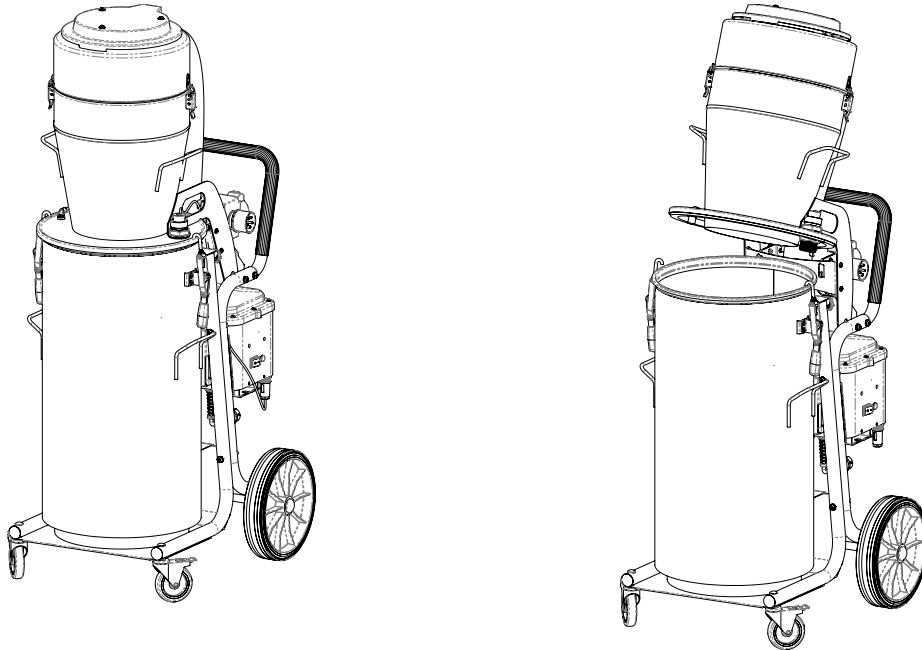

De stofafscheider heeft de volgende uitblaasmogelijkheid:

a- Container: Een cilindrische container voor het opvangen van gescheiden materiaal.

Technische gegevens

Technische gegevens	DC Chip Extractor
HxBxD [mm]	1530 x 600 x 780
Gewicht [kg]	70
Inlaat-Ø [mm]	76
Slanglengte Ø50mm [m]	7.5
Opvangcontainer [l]	90
Stroom max. ventilator (EU) 230V [w ³ /H]	355
Onderdruk max [kPa]	22
Stopcontact (EU) 230V [W]	2600
Fijnfilter polyester, oppervlak [m ²]	1.85
Filtervermogen fijnfilter, EN 60335-2-69, Klasse M [%]	99.9
Filteroppervlak microfilter [m ²]	2.2
Filterclassificatie, EN 1822-1	HEPA H13
Filtervermogen machine, EN 60335-2-69, Aanhangsel A-A, klasse H [%]	99.995
Geluidsniveau [dB(A)]	70
Art. nr.	174100

Operatie

Aansluiting

Sluit de machine aan op een stopcontact met spanning volgens de specificaties op het typeplaatje van de machine.

Automatische starter (ALV10)

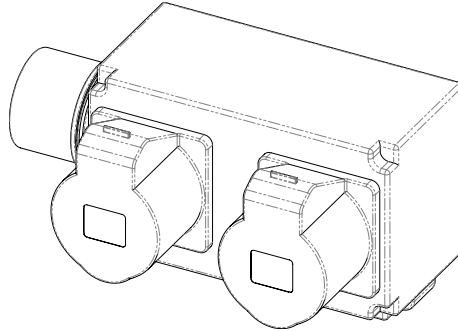

Volgens de huidige veiligheidsvoorschriften bij het werken met houtbewerkingsmachines moet gevaarlijk stof effectief worden opgezogen door een spanenafzuiger.

Deze starter met tijdsvertraging start automatisch de chipextractor na 2-3 seconden en beschermt daardoor tegen overbelasting van de zekering.

Nadat de machine is gestopt, gaat het spaanvacuüm nog 3-4 seconden door en zuigt zo het resterende stof uit de slangen.

Filterreiniging

De machine beschikt over een filterindicatielampje dat gaat branden wanneer het filter gereinigd of vervangen moet worden.

Instructies voor het reinigen van filters

1. Laat de machine aan staan, reset de filterreinigingsknop en sluit de klep op de cyclooninlaat.
2. Wacht 5-10 pulsen.
3. Schakel de machine uit.
4. Reset de filterreinigingsknop en open de demper op de cyclooninlaat.
5. Start de machine. Controleer of het filterindicatielampje uit is. Als dit niet het geval is, herhaalt u de procedure. Als de lamp ook na de herhaling blijft branden, moet het fijnfilter worden vervangen.



Droogleggen



LET OP

Niveausensoren waarschuwen wanneer het vat vol is en geleegd moet worden.

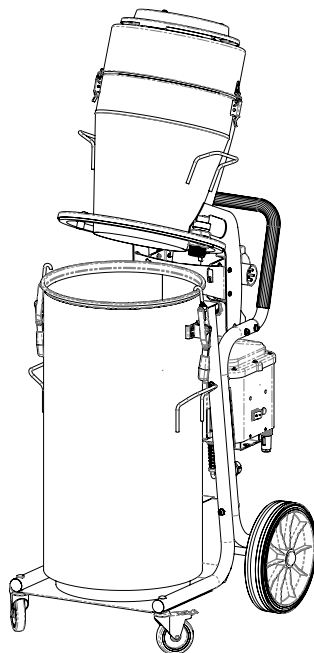

1. Maak de clips los waarmee het deksel aan het vat is bevestigd.
2. Til de achterkant van de cycloon op met behulp van de handgrepen aan de zijkant van de cycloon. Zie de bovenstaande afbeelding voor de positie van de cycloon.
3. Indien nodig kan de loop van het chassis worden getild.
4. Til de plastic zak eruit en knoop hem vast. Plaats een nieuwe plastic zak.
5. Plaats de cycloon terug op de loop en draai de gespen vast.

Service/onderhoud

Schoonmaken

Bij het reinigen en onderhouden van de machine moet de machine uitgeschakeld zijn en de stekker uit het stopcontact getrokken worden.

Filter vervangen

Het fijn filter moet ten minste eenmaal per jaar worden vervangen. Er mogen alleen originele filters worden gebruikt. HEPA-filters moeten na 300 uur worden vervangen.



WAARSCHUWING

Een filter vervangen mag alleen worden uitgevoerd door geïnstrueerd personeel. Gebruik een beschermend masker en geschikte apparatuur.



LET OP

Bij het vervangen van een filter mag geen gereedschap/slagen worden gebruikt, omdat deze het afdichtoppervlak van het filter kunnen beschadigen.

1. Maak het bovenste deel los en til het op om vrije toegang tot het filter te krijgen.

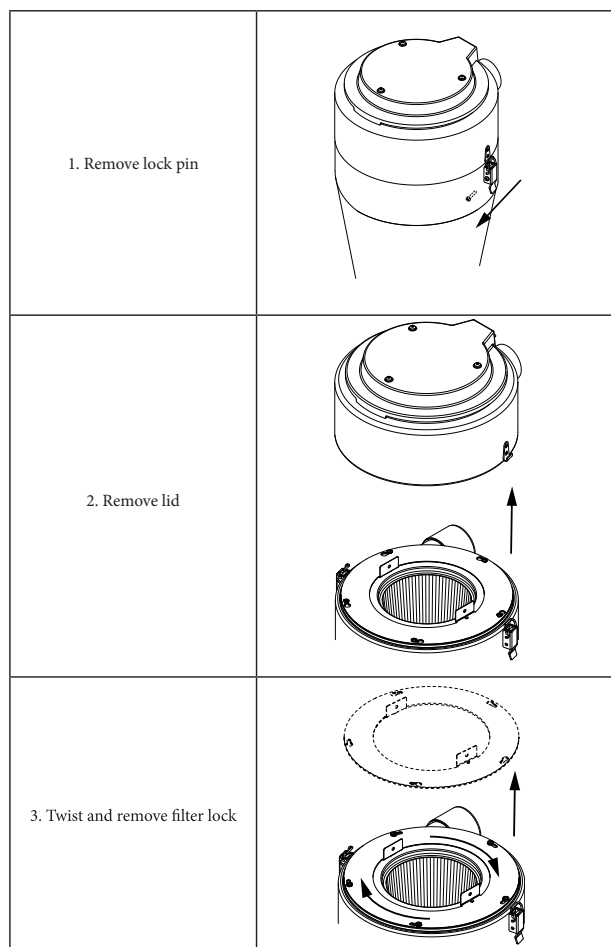

- 2.
3. Plaats de meegeleverde plastic zak over de cycloon om te voorkomen dat het stof in het filter zich verspreidt.
4. Til het filter recht omhoog.
5. Sluit de plastic zak af met het gebruikte filter.

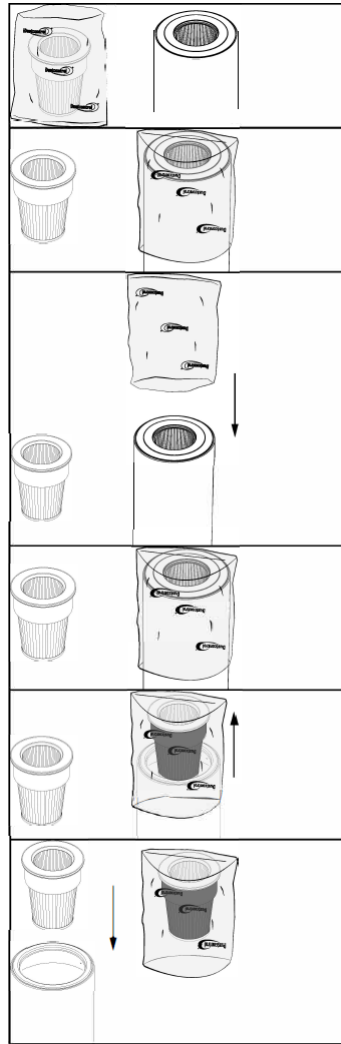

- 6.
7. Controleer bij het vervangen van het filter de pakking.
8. Een lekkende pakking kan het vrijkomen van voor de gezondheid gevaarlijk stof veroorzaken.
9. Gebruik nooit oude pakkingen of geplagieerde filters.
10. Vervangen filters moeten in een hersluitbare plastic zak worden geplaatst.

Motor

Voor ventilatormotoren is de typische levensduur van de originele borstels 600-700 uur. De borstels kunnen vervangen worden. De levensduur van het tweede borstelpakket is ongeveer 400 uur en het derde borstelpakket gaat ongeveer 300 uur mee. Hierna is de rotor versleten en moet de motor vervangen worden.

Oververhitting

Als de machine het risico loopt oververhit te raken (bijvoorbeeld door ernstige verstopping), reageert de temperatuursensor en de machine stopt. Het is dan belangrijk dat de operator de schakelaar op UIT-stand zet, de stekker uit het stopcontact haalt en 3-5 minuten wacht zodat de machine kan afkoelen. U reset de temperatuursensor vervolgens door op de knop RESET te drukken. Plaats de stekker weer in het stopcontact en start de machine opnieuw door de schakelaar op stand AAN te zetten.

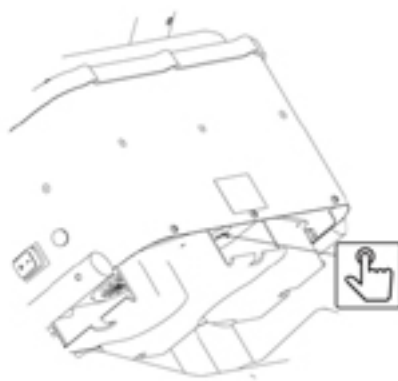

Regelmatige controle

Controleer regelmatig of het netsnoer niet beschadigd is.

Accessoires en verbruiksartikelen

Naam	Art. nr.
Aansluitmof	2008
Aansluitmof	2129
Slang Ø=50	2013
HEPA-filter	44016
Fijn filterpolyester	44017
Plastic zakken, 50 st.	4314
MOTOR 1285W 230V 50/60Hz	42309-01

Voor reserveonderdelen, zie de [website van Dustcontrol](#).

Garantie

De garantieperiode is twee jaar en heeft betrekking op fabricagefouten. De garantie geldt op voorwaarde dat de machine wordt gebruikt op normale wijze en de vereiste service ontvangt. Normale slijtage wordt niet vergoed. Reparaties moeten worden uitgevoerd door Dustcontrol of door een persoon die door Dustcontrol is goedgekeurd. Anders kan de garantie komen te vervallen.

Motor

De motor(en) van het product vallen niet onder de garantie. De levensduur van een monster voor een motor kan tussen 600 - 700 bedrijfsuren zijn. Neem contact op met Dustcontrol als u de motor moet vervangen.

Probleemoplossing

Probleem	Oorzaak	Maatregel
De motor werkt niet.	Elektriciteit niet aangesloten.	Sluit de elektriciteit aan.
De motor stopt direct na het starten.	Defecte zekering.	Vervang door een juiste zekering.
De motor loopt, maar de machine zuigt niet.	De zuigslang is niet aangesloten. Slang is verstopt.	Sluit de slang aan. Draai de slang of maak schoon.
De motor loopt, maar de machine zuigt slecht.	Gat in de zuigslang.	Vervang de slang.
	Verstopt filter.	Schoonmaken of vervangen.
	Zuigslang te lang of te smal.	Vervang de slang.
	Slang gedeeltelijk verstopt.	Draai de slang of maak schoon.
	De bovenkant van de machine niet goed geplaatst.	Plaats op de juiste manier.
	Er is stof vast komen te zitten in de cycloon.	Verwijder de bovenkant en maak de cycloon schoon.
De motor stopt tijdens bedrijf.	De motor is oververhit.	Controleer of de machine niet gesmoord is en wacht tot de machine is afgekoeld (ongeveer 30 min).
De machine blaast stof uit.	Het filter is losgeraakt of kapot.	Controleer en vervang indien nodig.
Abnormaal geluid van de machine.		Laat nakijken..

EG-verklaring

Hierbij verklaren wij dat de DC Chip Extractor voldoet aan de volgende voorschriften en normen:

2006/42/EC, 2014/30/EU, 2014/35/EU, EN 60204-1:2018, EN1822-1:2019.

Dustcontrol AB



Nina Uggowitzer / CEO & Technical Manager

2024-09-30

Contact

Dustcontrol Worldwide



AT
Dustcontrol Ges.m.b.H.
info@dustcontrol.at
www.dustcontrol.at



AU
All Preparation Equipment
www.allprep.com.au



BENELUX
Dust Solutions BV
www.dustsolutions.nl



BG
Metaltech14 Ltd.
metaltech14@abv.bg
www.dustcontrolbg.com



CA Dustcontrol
Canada Inc.
info@dustcontrol.ca
www.dustcontrol.ca



CH
Rosset Technik Maschinen
Werkzeuge AG
info@rosset-technik.ch
www.rosset-technik.ch



CL
Beckart Tecnologia Ambiental S.A.
ambitec@ambitec.cl
www.ambitec.cl



CN
Suzhou Dustcollect Filtration
Technology Co. Ltd.
wang@dustcollect.cn
www.dustcollect.cn



CZ / SK Ener
Group CZ, S.R.O. Infolinka:
+420 602 795 800
info@energrou.cz
www.prumysloveodsavani.cz/



DE
Dustcontrol GmbH
info@dustcontrol.de
www.dustcontrol.de



DK
Construction – Erenfred Pedersen A/S
info@ep.dk
www.ep.dk

Industry – Dansk Procesventilation ApS
info@dansk-procesventilation.dk
www.dansk-procesventilation.dk



EE
G-Color Baltic OÜ
sales@g-color.ee
www.g-color.ee



ES
Barin, s.a.
info@barin.es
www.barin.es



GB
Dustcontrol UK Ltd.
sales@dustcontrol.co.uk
www.dustcontrol.co.uk



GR
Mavrogiannakis S.A
ekttox@enternet.gr
www.ekttoxefis.com.gr



FI
Dustcontrol FIN OY
dc@dustcontrol.fi
www.dustcontrol.fi



FR
Construction – SMH Equipements
info@abequipements.com
www.smhequipements.com

Industry – Dustcontrol AB
info@dustcontrol.fra
www.dustcontrol.fra



HR
Kermek d.o.o.
kruno.nedeljko@kermek.com
www.kermek.com



HU
Vandras Kft
vandras@t-online.hu
www.vandras.hu



IN
Advance Ventilation Pve Ltd.
sales@advanceventilation.com
www.advanceventilation.com



IT
Airum srl
info@airum.com
www.airum.com



KR
ESH Engineering Co.
eshengco@gmail.com
www.eshengco.com



LT
UAB Hidromega
info@hidromega.lt
www.hidromega.lt



LV
SIA Reaktivs
reaktivs@reaktivs.lv
www.reaktivs.lv



MY, ID
Stada EnviroSpace Bhd
info@stada.com.my
www.stada.com.my



NO
Teijo Norge A.S
firmapost@teijo.no
www.teijo.no



NZ
Artizan Diamond Tools
enquiry@artizandiamond.co.nz
www.artizandiamond.co.nz



PE
Efixo
contacto@efixo.pe
www.efixo.pe



PH
Sweden Concrete Machines Inc.
peringe@packoskick.se
www.swedenconcretemachines.ph



PL
Bart Sp. z o.o.
info@bart-vent.pl
www.bart-vent.pl



PT
Metec-Mecano Técnica, Lda.
geral@metec.pt
www.metec.pt



RO
AWS Elektrotehnik
office@awstehnik.ro
www.awstehnik.ro

General Contractor Industry SRL
office@gci-grup.ro
www.gci-grup.ro



RS
Enel Alati
eneldoo@eunet.rs
www.eneldoo.rs



RU
Centre Vacuum System
panov.g@movers-td.com
www.dustcontrolrus.ru



SE
Dustcontrol AB
info@dustcontrol.se
www.dustcontrol.com



SG
Stada EnviroSpace Pte Ltd
Info@stada.com.my
www.stada.com.my



TW
Goodland Enterprise Co., Ltd.
sales@goodland.com.tw
www.goodland.com.tw



TH
MCON Intertrade Co., Ltd.
sales@mconintertrade.com
www.mconintertrade.com



TR Ventek
Mühendislik Ltd.
info@ventek.com.tr
www.ventek.com.tr



AE
Global Enterprises Trading Co L.L.C.
sales@globalentco.com
www.globalentco.com

GEM
Industrial Equipment Trading Co. Tel:
+971 4 8840 474
Email: gemuae@eim.ae



UA
MBK Obshemashkontrakt, JSC
zao@omk.dp.ua
www.omk.dp.ua



US
Dustcontrol Inc.
info@dustcontrolusa.com
www.dustcontrol.us



VN
Tayhostar JSC
tayhostar@tayhostar.vn
www.tayhostar.vn

Please contact the head office
in Sweden if you do not find a
distributor in your area.
info@dustcontrol.se